

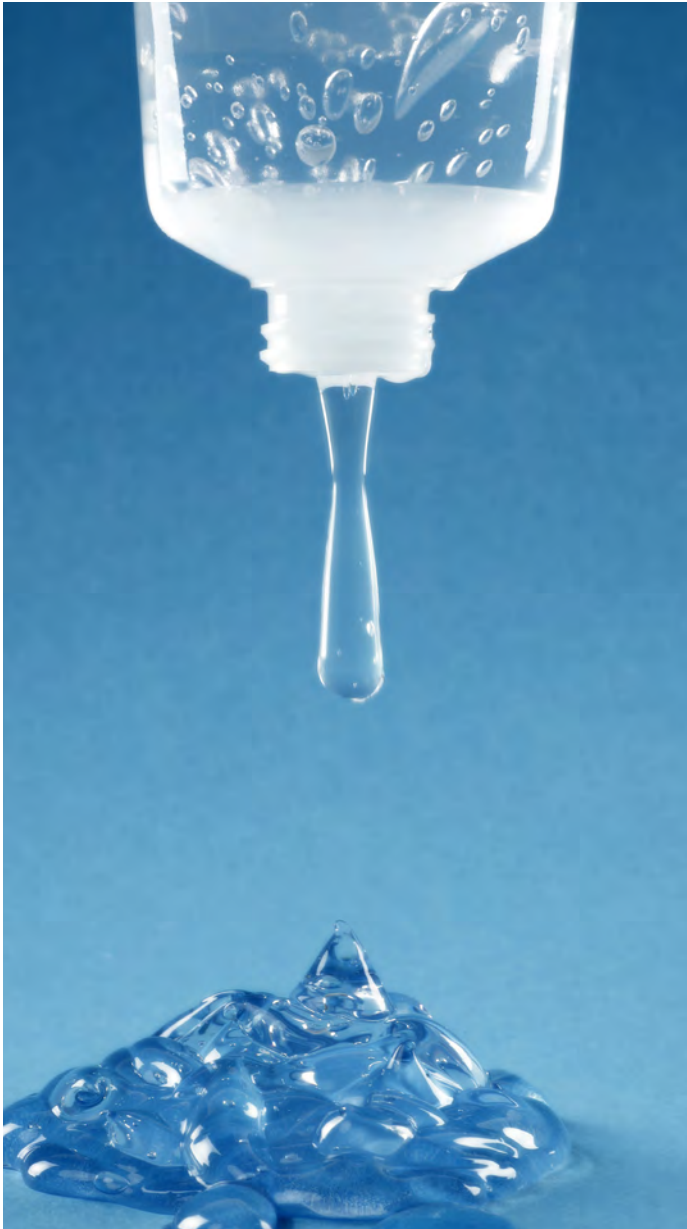

BERRY ASTRAPAK

GENERAL
TRADE RANGE
BROCHURE



WHO WE ARE	2
SUSTAINABILITY	5
SECTION 1 // BOTTLES	6
SECTION 2 // JARS	11
SECTION 3 // TUBS	15
SECTION 4 // CLOSURES	18
SECTION 5 // ROLL-ONS	24
SECTION 6 // TUBES	26
SECTION 7 // CUPS & TRAYS	45
SECTION 8 // MISCELLANEOUS	68

INTRODUCTION

Berry Astrapak is a specialised manufacturer of an extensive range of rigid moulded, and thermoformed plastic packaging products serving the African market.

The Group focuses on innovation-led growth in plastic packaging and is structured for long-term sustainability through a balance of organic and project-based growth.

In June 2018, RPC-Astrapak acquired Spec Group, which is made up of three well-known businesses being Spec Tool & Die, Spec Design and Spec Molders. The acquisition was a major milestone in the expansion of Berry Astrapak, providing the company with its own in-house design and mould-making capability along with an experienced management and manufacturing team.

The three divisions which define Berry Astrapak are:

- Moulding
- Forming
- Innovation and Design

OUR SITES

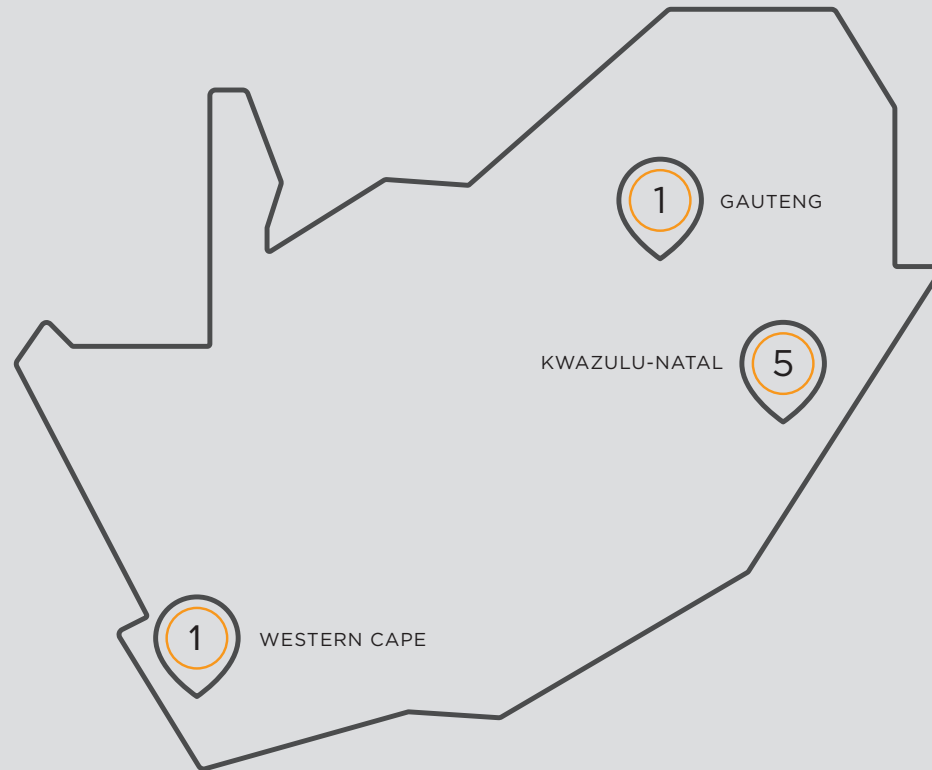

7 OPERATIONS // 3 PROVINCES // C. 1,500 EMPLOYEES

GAUTENG
Marcom

KWAZULU-NATAL
Plastop
Pak 2000
Consupaq
JJ Precision

WESTERN CAPE
Forming Businesses
Thermopac

KWAZULU-NATAL
Innovation & Design Centre
Spec Group

MOULDING

Berry Astrapak's Moulding Division is the biggest of the Group's two manufacturing divisions and falls within the rigid plastic packaging spectrum.

ABOUT MOULDING

With six plants across South Africa, Moulding provides a range of markets with superior quality plastic packaging solutions. From the petrochemical market to the cosmetics, food and personal care markets, Berry Astrapak ensures that their client's premium product is packaged to the highest quality standards.

TECHNOLOGY

A wide range of closures, jars, bottles, tubes, cups, tubs and other plastic containers up to a size of five litres are manufactured through the process of extrusion-blow moulding (EBM), injection-blow moulding (IBM) and injection moulding (IM). Decorative techniques include foiling, pressure sensitive labelling, sleeving and printing. Berry Astrapak Marcom serves the dairy market and manufactures thin walled injection-moulded tubs, containers, lids and cups for dairy applications – with in-mould labelling and offset decoration technologies.

MARKETS

Moulding services the automotive lubricant and industrial chemical, food, personal care, home care and cosmetic markets offering customised product to customer's specifications.

FORMING

Forming is one of two manufacturing divisions of the Group and is categorised as a Rigids product manufacturer. The Forming division has two plants in South Africa, both located in the Western Cape.

ABOUT FORMING

Forming provides the market with a wide range of thermoformed and moulded packaging, improving and enhancing their customer's shelf presence. Forming products include thermoformed cups, tubs and trays for dairy and other food applications, together with decorative options. These products have become market leaders in the dairy industry with Forming developing bespoke packaging tubs for some of South Africa's prominent dairy brands and chain stores.

TECHNOLOGY

Berry Astrapak Thermopac and Berry Astrapak Plastform's facilities extrude their own sheet requirements. Plastform has a state-of-the-art sheet extruder to produce sheet film that is then thermoformed. There is an extensive range of generic products available to the market, and both operations also offer the opportunity to develop a unique shape offering to its customer base.

MARKETS

Forming has a well-established presence in the Dairy, Food and Beverage markets, offering their customers a unique and competitive advantage.



INNOVATION AND DESIGN

SPEC INNOVATION & DESIGN CENTRE

Established in 1991, the Durban-based company specialises in the design, manufacture and repair of plastic moulding tools and dies. Spec Tool & Die established Spec Molders, a manufacturing arm of the business, in 2004; and Spec Molders was integrated into the existing operations during September 2018.

Spec Group is widely renowned as one of South Africa's largest independent and most innovative toolrooms through Spec Tool & Die and Spec Design. Their reputation is proven by the immensely successful partnership already demonstrated through the award-winning innovative designs achieved in conjunction with RPC Astrapak prior to the acquisition.

For those bespoke products that don't "fit the mould", let our innovative design team present a unique packaging solution for you and your brand to differentiate your packaging in the market place.

ACCESSING BERRY THROUGH BERRY ASTRAPAK

The acquisition of Spec Group strengthens Berry Astrapak's synergy with Berry Group. Berry has a successful track record of innovation and speed to market using world-class technology, which Berry Astrapak is now in a position to access and emulate.

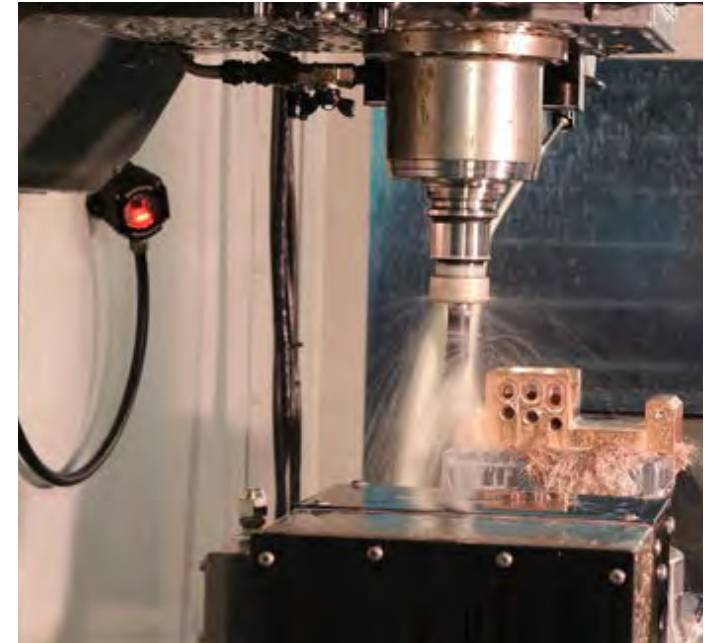

INDUSTRY WASTE MANAGEMENT PLAN & SUSTAINABILITY

AIM OF IWMP

- To improve the overall waste management in SA
 - To reduce waste to landfill
 - To create well-structured and formalised industry to control waste to landfill
 - To represent all packaging converters and brand owners

PROPOSED BENEFITS

- Waste reduction and improved resource efficiency
- Cost savings in plastic recycling
- Lowered environmental impact
- Greater safety for workers, minimising impact on surrounding communities
- Improve awareness through empowering workers and communities

SUSTAINABILITY MATTERS











- Creating a sustainable future for generations to come is a core commitment of the Berry Group
- Sustainability underscores everything that we do -both the products that we manufacture and the way we run our operations
- We work to ensure that we meet all our own environmental responsibilities and to help our customers achieve theirs
- Lightweighting for transport makes a significant contribution to reduce carbon footprint and minimise raw material usage
- Circular economy - maintain a closed loop process to reduce waste to landfill
- Contribute to organisations like Polyco for recycling packaging
- Currently using rPET and rHDPE in our manufacturing process















SECTION 1 //

BOTTLES

<p>5L GENERAL PURPOSE P2K_PAK558</p>  <p>● ● ●</p> <ul style="list-style-type: none"> ⊗ 38mm ⌘ Ratchet, Screw ⌚ Jerry Can ⊞ HDPE ⌚ Tear off (Optional Seal) <p style="text-align: right;">①</p>	<p>5L GENERAL PURPOSE RIBBED P2K_PAK564</p>  <p>● ● ●</p> <ul style="list-style-type: none"> ⊗ 38mm ⌘ Ratchet, Screw ⌚ Jerry Can ⊞ HDPE ⌚ Tear off (Optional Seal) <p style="text-align: right;">①</p>	<p>1L GENERAL PURPOSE 38MM NECK P2K_PAK394</p>  <p>● ● ●</p> <ul style="list-style-type: none"> ⊗ 38mm ⌘ Ratchet, Screw ⌚ Round ⊞ HDPE ⌚ Tear off (Optional Seal) <p style="text-align: right;">①</p>	<p>1L GENERAL PURPOSE 28MM NECK P2K_PAK409</p>  <p>● ● ●</p> <ul style="list-style-type: none"> ⊗ 28mm ⌘ Ratchet, Screw ⌚ Round, Conical ⊞ HDPE ⌚ Tear off (Optional Seal) <p style="text-align: right;">②</p>	<p>500ML GENERAL PURPOSE 28MM NECK P2K_PAK323</p>  <p>● ● ●</p> <ul style="list-style-type: none"> ⊗ 28mm ⌘ Ratchet, Screw ⌚ Round, Conical ⊞ HDPE ⌚ Automotive / Industrial (Lined); Gear oil with spigot <p style="text-align: right;">② ③</p>	<p>RELATED PRODUCTS</p> <p>CLOSURES</p> <ul style="list-style-type: none"> ① 38MM WHITE LITE CLOSURE JJP_PAK156 PG 19 ② 28MM AUTOMOTIVE / INDUSTRIAL JJP_PAK021 PG 19 ③ 28MM GEAR OIL WITH SPIGOT JJP_PAK030 PG 19
<p>200ML GENERAL PURPOSE P2K_PAK059</p>  <p>● ● ●</p> <ul style="list-style-type: none"> ⊗ 28mm ⌘ Ratchet, Screw ⌚ Round, Conical ⊞ HDPE ⌚ Automotive / Industrial (Lined) <p style="text-align: right;">②</p>	<p>750ML GENERAL PURPOSE WHITE HDPE PLA_B066B02</p>  <p>●</p> <ul style="list-style-type: none"> ⊗ 31mm ⌘ Tear off ⌚ Round, Conical ⊞ HDPE, Glossy ⌚ Tear off, Frustum 	<p>5L JERRY CAN CLEAR 120G PLA_B072C01</p>  <p>○</p> <ul style="list-style-type: none"> ⊗ 38mm ⌘ Screw ⌚ Jerry Can ⊞ HDPE, Matt ⌚ Screw, Frustum 	<p>2L JERRY CAN CLEAR (3 START) PLA_B07101</p>  <p>○</p> <ul style="list-style-type: none"> ⊗ 38mm ⌘ Screw ⌚ Jerry Can ⊞ HDPE, Matt ⌚ Screw, Frustum 	<p>1L HAND CAN CLEAR (3 START) PLA_B07001</p>  <p>○</p> <ul style="list-style-type: none"> ⊗ 38mm ⌘ Screw ⌚ Jerry Can ⊞ HDPE, Matt ⌚ Screw, Frustum 	

⊗ NECK DIAMETER ⌘ NECK TYPE ⌚ SHAPE ⊞ MATERIAL ⌚ CLOSURE / ○ STANDARD COLOUR OPTIONS AVAILABLE

<p>5L AUTOMOTIVE P2K_PAK551</p>  <p>● ● ● ○</p> <ul style="list-style-type: none"> ⊗ 38mm ⌘ Ratchet, Screw ⊞ Rectangular ⊞ HDPE, Matt ⌘ Frustum / Liner <p style="text-align: right;">①</p>	<p>1L AUTOMOTIVE P2K_PAK398</p>  <p>● ● ● ○</p> <ul style="list-style-type: none"> ⊗ 38mm ⌘ Ratchet, Screw ⊞ Rectangular ⊞ HDPE, Matt ⌘ Frustum / Liner, Tear off (Optional Seal) <p style="text-align: right;">①</p>	<p>500ML AUTOMOTIVE P2K_PAK297</p>  <p>● ● ● ○</p> <ul style="list-style-type: none"> ⊗ 28mm ⌘ Ratchet, Screw ⊞ Rectangular ⊞ HDPE, Matt ⌘ Frustum / Liner <p style="text-align: right;">②</p>	<p>200ML AUTOMOTIVE P2K_PAK052</p>  <p>● ● ● ○</p> <ul style="list-style-type: none"> ⊗ 28mm ⌘ Ratchet, Screw ⊞ Rectangular ⊞ HDPE, Matt ⌘ Frustum / Liner <p style="text-align: right;">②</p>	<p>2L FOAM BATH BOTTLE RPC_GN0016</p>  <p>○</p> <ul style="list-style-type: none"> ⊗ 28mm ⌘ Screw ⊞ Flat, Oval handle ⊞ HDPE, Smooth ⌘ Frustum, Umbrella Cap <p style="text-align: right;">③</p>	<p>RELATED PRODUCTS</p> <p>CLOSURES</p> <ul style="list-style-type: none"> ① 38MM WHITE LITE CLOSURE JJP_PAK156 PG 19 ② 28MM AUTOMOTIVE / INDUSTRIAL JJP_PAK021 PG 19 ③ 2L FOAM BATH CLOSURE JJP_GEN170 PG 19
<p>750ML GENERAL PURPOSE PLA_S002STB01</p>  <p>● ○</p> <ul style="list-style-type: none"> ⊗ 31mm ⌘ Tear off ⊞ Round, Conical ⊞ PET, Smooth ⌘ Tear off, Frustum 	<p>500ML GENERAL PURPOSE PLA_S060STB01</p>  <p>○</p> <ul style="list-style-type: none"> ⊗ 31mm ⌘ Tear off ⊞ Round, Conical ⊞ PET, Smooth ⌘ Tear off, Frustum 	<p>375ML GENERAL PURPOSE PLA_S050STB01</p>  <p>○</p> <ul style="list-style-type: none"> ⊗ 31mm ⌘ Tear off ⊞ Round, Conical ⊞ PET, Smooth ⌘ Tear off, Frustum 	<p>750ML CECIL PLA_S005STB01</p>  <p>○</p> <ul style="list-style-type: none"> ⊗ 31mm ⌘ Tear off ⊞ Round, Flat ⊞ PET, Smooth ⌘ Tear off, Frustum 	<p>375ML CECIL PLA_S051STB01</p>  <p>○</p> <ul style="list-style-type: none"> ⊗ 31mm ⌘ Tear off ⊞ Round, Flat ⊞ PET, Smooth ⌘ Tear off, Frustum 	

⊗ NECK DIAMETER ⌘ NECK TYPE ⊞ SHAPE ⊞ MATERIAL ⌘ CLOSURE / ○ STANDARD COLOUR OPTIONS AVAILABLE

200ML SCALLOP GP
PLA_4078



- ⊗ 31mm
- 🔧 Snap on
- 📏 Round
- 🌿 PET, Smooth
- 🗑️ Snap on, Frustum

①

2L PET CARBONATED
PLA_S104SAB01



- ⊗ 28mm
- 🔧 Screw
- 📏 Round
- 🌿 PET, Smooth
- 🗑️ Screw Cap

500G HONEY SQUEEZE
PLA_S083SSC01



- ⊗ 42mm
- 🔧 Snap on
- 📏 Oval
- 🌿 PET, Smooth
- 🗑️ Snap on, Frustum, TE

375G HONEY SQUEEZE
PLA_S084SSC01



- ⊗ 42mm
- 🔧 Snap on
- 📏 Oval
- 🌿 PET, Smooth
- 🗑️ Snap on, Frustum, TE

200ML SHOULDER BOTTLE
PLA_S077SSC01



- ⊗ 24mm
- 🔧 24/400, Screw
- 📏 Flat, Oval
- 🌿 PET, Smooth
- 🗑️ Screw, Frustum

①

RELATED PRODUCTS
CLOSURES

- ① 24/400 CLOSURE
JJP_GEN151 PG 20
- ② 18/400 CLOSURE
JJP_GEN141 PG 20

100ML SHOULDER BOTTLE
PLA_S076SSC01



- ⊗ 24mm
- 🔧 24/400, Screw
- 📏 Flat, Oval
- 🌿 PET, Smooth
- 🗑️ Screw, Frustum

①

50ML SHOULDER BOTTLE
PLA_S075SSC01









- ⊗ 18mm
- 🔧 18/400, Screw
- 📏 Flat, Oval
- 🌿 PET, Smooth
- 🗑️ Screw, Frustum

②













<p>340ML MEDIPAC PZN_B8700S/0001</p>  <p>④ 45mm ① Screw ② Round ③ PP, Glossy ④ Screw, Liner</p>	<p>260ML MEDIPAC PZN_B8699S/0001</p>  <p>④ 45mm ① Screw ② Round ③ PP, Glossy ④ Screw, Liner</p>	<p>175ML MEDIPAC PZN_B8698S/0001</p>  <p>④ 38mm ① Screw ② Round ③ PP, Glossy ④ Screw, Frustum, Liner</p>	<p>RELATED PRODUCTS CLOSURES</p> <p>① 45MM TE MEDICAP WHITE LINED JJP_GEN210 PG 21</p> <p>② 38MM TE MEDICAP WHITE JJP_GEN209 PG 21</p> <p>③ DROPPER PLUG JJP_GEN184 PG 23</p> <p>④ DROPPER CAP JJP_GEN173 PG 23</p>
<p>145ML MEDIPAC PZN_B8697S/0001</p>  <p>④ 38mm ① Screw ② Round ③ PP, Glossy ④ Screw, Frustum</p>	<p>5ML DROPPER BOTTLE PZN_B8695S/0002</p>  <p>④ 13mm ① Screw ② Round ③ LDPE, Glossy ④ Screw, Frustum, Plug</p>	<p>15ML DROPPER BOTTLE PZN_B8695S/0001</p>  <p>④ 13mm ① Screw ② Round ③ LDPE, Glossy ④ Screw, Frustum, Plug</p>	

④ NECK DIAMETER ① NECK TYPE ② SHAPE ③ MATERIAL ④ CLOSURE / ○ STANDARD COLOUR OPTIONS AVAILABLE





SECTION 2 //









JARS

<p>500ML NT JAR CON_CON340</p>  <ul style="list-style-type: none"> ① 88mm ① Screw ① Round ① PP, Smooth ① 250ml, 500ml NT Lid 	<p>250ML NT JAR CON_CON336</p>  <ul style="list-style-type: none"> ① 88mm ① Screw ① Round ① PP, Smooth ① 250ml, 500ml NT Lid 	<p>500ML JAR CON_CON120</p>  <ul style="list-style-type: none"> ② 97mm ② Screw ② Round ② PP, Smooth ② 250ml, 500ml Lid 	<p>250ML JAR CON_CON088</p>  <ul style="list-style-type: none"> ③ 84mm ④ Screw ④ Round ④ PP, Smooth ④ 125ml, 250ml Shive ④ 125ml, 250ml Lid 	<p>125ML JAR CON_CON044</p>  <ul style="list-style-type: none"> ⑤ 72.5mm ⑤ Screw ⑤ Round ⑤ PP, Smooth ⑤ 125ml Lid 	<p>RELATED PRODUCTS CLOSURES</p> <ul style="list-style-type: none"> ① 250ML / 500ML NT LID CON_CON342 PG 22 ② 250ML / 500ML LID CON_CON531 PG 22 ③ 125ML / 250ML SHIVE CON_CON116 PG 21 ④ 125ML / 250ML LID CON_CON109 PG 22 ⑤ 125ML LID CON_CON060 PG 22 ⑥ 125ML NT LID CON_CON345 PG 22 	
<p>125ML PW SLIM JAR CON_CON520</p>  <ul style="list-style-type: none"> ③ 84mm ④ Screw ④ Round ④ PP, Smooth ④ 125ml, 250ml Shive ④ 125ml, 250ml Lid 	<p>125ML NT JAR CON_CON332</p>  <ul style="list-style-type: none"> ⑥ 72mm ⑥ Screw ⑥ Round ⑥ PP, Smooth ⑥ 125ml NT Lid 	<p>250ML CLEAR SLIM JAR CON_CON092</p>  <ul style="list-style-type: none"> ② 97mm ② Screw ② Round ② PP, Smooth ② 250ml, 500ml Lid 				

① NECK DIAMETER ② NECK TYPE ③ SHAPE ④ MATERIAL ⑤ CLOSURE / ⑥ STANDARD COLOUR OPTIONS AVAILABLE

<p>30ML / 50ML CRYSTAL ROUND JAR CON_CON176</p>  <p>○</p> <ul style="list-style-type: none"> ① 54mm ② Screw ⑧ Round ⑨ SAN, Smooth ⑩ 50ml Shive 50ml Lid 	<p>30ML / 50ML CRYSTAL CONVEX JAR CON_CON167</p>  <p>○</p> <ul style="list-style-type: none"> ① 54mm ② Screw ⑧ Round, Convex ⑨ SAN, Smooth ⑩ 50ml Shive 50ml Lid 	<p>30ML / 50ML CRYSTAL SQUARE JAR CON_CON174</p>  <p>○</p> <ul style="list-style-type: none"> ① 54mm ② Screw ⑧ Round ⑨ SAN, Smooth ⑩ 50ml Shive 50ml Lid 	<p>30ML / 50ML SLIMLINE CRYSTAL JAR CON_CON378</p>  <p>○</p> <ul style="list-style-type: none"> ① 54mm ② Screw ⑧ Round ⑨ SAN, Smooth ⑩ 50ml Shive 50ml Lid 	<p>30ML/50ML CRYSTAL CONCAVE JAR CON_CON177</p>  <p>○</p> <ul style="list-style-type: none"> ① 54mm ② Screw ⑧ Round, Concave ⑨ SAN, Smooth ⑩ 50ml Shive 50ml Lid 	<p>RELATED PRODUCTS</p> <p>CLOSURES</p> <ul style="list-style-type: none"> ① 50ML CRYSTAL JAR WHITE LID CON_CON183 PG 22 ② CRYSTAL JAR LID FLAT CON_CON432 PG 22 ③ 50ML LID CLEAR CON_CON368 PG 22 ④ 50ML SHIVE CON_CON389 PG 21 ⑤ 125ML / 250ML SHIVE CON_CON116 PG 21 ⑥ 125ML / 250ML LID CON_CON109 PG 22 ⑦ 33MM CLEAR JAR CLOSURE JJP_GEN073 ⑧ 30ML/50ML APPLICATOR SHIVE CON_CON190 PG 21 <p>JARS</p> <ul style="list-style-type: none"> ⑨ 30ML INNER JAR CON_CON151 PG 13 ⑩ 50ML INNER JAR CON_CON153 PG 13 ⑪ 30ML / 50ML CRYSTAL ROUND JAR CON_CON176 PG 13 ⑫ 30ML / 50ML CRYSTAL CONVEX JAR CON_CON167 PG 13 ⑬ 30ML / 50ML CRYSTAL SQUARE JAR CON_CON174 PG 13 ⑭ 30ML / 50ML SLIMLINE CRYSTAL JAR CON_CON378 PG 13 ⑮ 50ML COMBI JAR CON_CON367 PG 13 ⑯ 125ML PW SLIM JAR CON_CON520 PG 12 ⑰ 250ML JAR CON_CON088 PG 12 ⑱ 50ML CLEAR JAR CON_CON366 PG 13
<p>50ML INNER JAR CON_CON153</p>  <p>●</p> <ul style="list-style-type: none"> ① NA ② Screw ⑪ Round ⑫ HDPE / PP, Smooth ⑬ 50ml Shive ⑭ 50ml Lid 	<p>30ML INNER JAR CON_CON151</p>  <p>●</p> <ul style="list-style-type: none"> ① NA ② Screw ⑪ Round ⑫ HDPE / PP, Smooth ⑬ 50ml Shive ⑭ 50ml Lid 	<p>50ML CLEAR JAR CON_CON366</p>  <p>● ○</p> <ul style="list-style-type: none"> ③ 57.5mm ④ Screw ⑮ Round ⑯ PP, Smooth NA 	<p>125ML COMBI JAR CON_CON033</p>  <p>● ○</p> <ul style="list-style-type: none"> ⑤ 84mm ⑥ Screw ⑮ Round ⑰ PP, Smooth Shive 	<p>50ML COMBI JAR CON_CON367</p>  <p>● ○</p> <ul style="list-style-type: none"> ③ 57.5mm ④ Screw ⑮ Round ⑰ PP, Smooth NA 	

① NECK DIAMETER ② NECK TYPE ③ SHAPE ④ MATERIAL ⑤ CLOSURE / ○ STANDARD COLOUR OPTIONS AVAILABLE











<p>10ML CLEAR JAR JJP_GEN109</p>  <p>①</p> <ul style="list-style-type: none"> ③ 33mm 🔧 Screw 📏 Round 🌟 SAN, Glossy 👤 Frustum 	<p>BLOOD VIAL 10x75 CON_CON202</p>  <p>○</p> <ul style="list-style-type: none"> ③ 10mm 🔧 NA 📏 Round 🌟 PS, Smooth 👤 NA 	<p>BLOOD VIAL 12x75 CON_CON203</p>  <p>○</p> <ul style="list-style-type: none"> ③ 12mm 🔧 NA 📏 Round 🌟 PS, Smooth 👤 NA 	<p>100G PET JELLY CLEAR PLA_S081SSC010</p>  <p>○</p> <ul style="list-style-type: none"> ② ③ 50mm 🔧 50/400, Screw 📏 Round 🌟 PET, Smooth 👤 Top seal / Liner 	<p>50G PET JELLY CLEAR PLA_S080SSC010</p>  <p>○</p> <ul style="list-style-type: none"> ③ ③ 38mm 🔧 38/400, Screw 📏 Round 🌟 PET, Smooth 👤 Top seal / Liner 	<p>RELATED PRODUCTS</p> <p>CLOSURES</p> <ul style="list-style-type: none"> ① 33MM SCREW ON CLOSURE JJP_GEN073 PG 21 ② 50/400 CLOSURE JJP_GEN148 PG 20 ③ 38/400 CLOSURE JJP_GEN123 PG 20 ④ 24MM TEAR OFF CAP JJP_GEN127 PG 20 
<p>25ML PET VIAL CLEAR PLA_S044STC01</p>  <p>○</p> <ul style="list-style-type: none"> ④ ③ 24mm 🔧 Snap on 📏 Round 🌟 PET, Smooth 👤 Frustum 	<p>STICK CON_CON194</p>  <p>○</p> <ul style="list-style-type: none"> ③ NA 🔧 Slide on 📏 Round 🌟 PP / LD, Smooth 👤 NA 				

③ NECK DIAMETER 🔧 NECK TYPE 📏 SHAPE 🌟 MATERIAL 👤 CLOSURE / ○ STANDARD COLOUR OPTIONS AVAILABLE



SECTION 3 //

TUBS

<p>100G 6 PACK YOGHURT TUB MAR_A000.0100.67V.WIZZ.0</p>  <ul style="list-style-type: none"> ⊗ NA ⌂ NA 📦 6 Pack 🌀 PP, Smooth 📅 Foil 	<p>1KG TUB MAR_A000.1000.12J.W2ZZ.0</p>  <ul style="list-style-type: none"> ⊗ NA ⌂ NA 📦 Round 🌀 PP, Smooth 📅 Clip on Lid, Tamper Evident, Foil 	<p>500G TUB MAR_A000.0500.12I.WIZZ.0</p>  <ul style="list-style-type: none"> ⊗ NA ⌂ NA 📦 Round 🌀 PP, Smooth 📅 Clip on Lid, Tamper Evident, Foil 	<p>250ML TUB MAR_A000.0250.11E.W2ZZ.0</p>  <ul style="list-style-type: none"> ⊗ NA ⌂ NA 📦 Round 🌀 PP, Smooth 📅 Foil 	<p>175G TUB MAR_A000.0175.11E.W2ZZ.0</p>  <ul style="list-style-type: none"> ⊗ NA ⌂ NA 📦 Round 🌀 PP, Smooth 📅 Foil 	<p>RELATED PRODUCTS</p> <p>CLOSURES</p> <ul style="list-style-type: none"> ① WHITE LID (FOR 1KG TUB) MAR_A000.0122.82J.B2ZZ.0 PG 20 ② WHITE LID (FOR 500G TUB) MAR_A000.0090.82I.BIZZ.0 PG 20 ③ 70MM DOME LID (FOR 80ML TUB) MAR_A000.0070.93E.WIZZ.0 PG 20 ④ 70MM FLAT LID (FOR 80ML TUB) MAR_A000.0070.83E.WIZZ.0 PG 20 ⑤ CLEAR LID (FOR 250G PEDESTAL TUB) MAR_A000.0095.83G.W2ZZ.0 PG 20 ⑥ 500G GREASE LID JJP_PAK091 PG 23
<p>150G TUB MAR_A000.0150.11E.W0ZZ.0</p>  <ul style="list-style-type: none"> ⊗ NA ⌂ NA 📦 Round 🌀 PP, Smooth 📅 Foil 	<p>125ML TUB MAR_A000.0125.11B.C6ZZ.0</p>  <ul style="list-style-type: none"> ⊗ NA ⌂ NA 📦 Round 🌀 PP, Smooth 📅 Foil 	<p>80ML TUB MAR_A000.0080.11E.W0ZZ.0</p>  <ul style="list-style-type: none"> ⊗ NA ⌂ NA 📦 Round 🌀 PP, Smooth 📅 Foil, Clip on Lid 	<p>150G PEDESTAL TUB MAR_A000.0150.31G.COZZ.0</p>  <ul style="list-style-type: none"> ⊗ NA ⌂ NA 📦 Round 🌀 PP, Smooth 📅 Clip on Lid 	<p>500G GREASE TUB JJP_PAK099</p>  <ul style="list-style-type: none"> ⊗ 95mm ⌂ Screw 📦 Round 🌀 PP, Glossy 📅 None, ExPE Option 	

⊗ NECK DIAMETER ⌂ NECK TYPE 📦 SHAPE 🌀 MATERIAL 📅 CLOSURE / ○ STANDARD COLOUR OPTIONS AVAILABLE



500G TUB
RPC_GN0018



- ⊗ NA
 - ⌘ NA
 - ⏏ Round, Tapered
 - 🌀 PP, Smooth
 - 🔒 Clip on Lid
- ①

RELATED PRODUCTS
CLOSURES











① 500G TUB LID
RPC_GN0019

PG 23





SECTION 4 //

CLOSURES













<p>24MM FLIP TOP WITH SECURITY SEAL JJP_GEN126</p>  <p>● ● ● ●</p> <ul style="list-style-type: none"> ⊘ 24mm 🔩 Snap on 📐 Round 🌿 PET, Glossy 🗑️ Frustum 	<p>44MM SHOULDER CAP JJP_GEN085</p>  <p>●</p> <ul style="list-style-type: none"> ⊘ 24mm 🔩 Screw 📐 Round 🌿 HDPE / PP, Glossy 🗑️ Spigot 	<p>36MM SHOULDER CAP JJP_GEN076</p>  <p>●</p> <ul style="list-style-type: none"> ⊘ 24mm 🔩 Screw 📐 Round 🌿 HDPE / PP, Glossy 🗑️ Spigot 	<p>38MM AUTOMOTIVE / INDUSTRIAL JJP_PAK158</p>  <p>● ●</p> <ul style="list-style-type: none"> ⊘ 38mm 🔩 Screw 📐 Round 🌿 HDPE, Ribbed, Glossy 🗑️ IHS Liner 	<p>40MM NIGHT ROD™ JJP_PAK198</p>  <p>●</p> <ul style="list-style-type: none"> ⊘ 40mm 🔩 Screw 📐 Round 🌿 HDPE, Ribbed, Matt 🗑️ IHS Liner 	<p>RELATED PRODUCTS</p> <p>BOTTLES</p> <ul style="list-style-type: none"> ① 5L GENERAL PURPOSE P2K_PAK558 PG 7 ② 5L GENERAL PURPOSE RIBBED P2K_PAK564 PG 7 ③ 1L GENERAL PURPOSE 38MM P2K_PAK394 PG 7 ④ 5L AUTOMOTIVE P2K_PAK551 PG 8 ⑤ 1L AUTOMOTIVE P2K_PAK398 PG 8 ⑥ 1L GENERAL PURPOSE 28MM P2K_PAK409 PG 7 ⑦ 500ML GENERAL PURPOSE 28MM P2K_PAK323 PG 7 ⑧ 200ML GENERAL PURPOSE P2K_PAK059 PG 7 ⑨ 500ML AUTOMOTIVE P2K_PAK297 PG 8 ⑩ 200ML AUTOMOTIVE P2K_PAK052 PG 8 ⑪ 2L FOAM BATH BOTTLE RPC_GN0016 PG 8 <p>CLOSURES</p> <ul style="list-style-type: none"> ⑫ 16MM PLUG - 4MM ORIFICE JJP_GEN108 PG 21 ⑬ 12MM PLUG - 4MM ORIFICE JJP_GEN107 PG 21 ⑭ 28MM GEAR OIL WITH SPIGOT JJP_PAK030 PG 19 ⑮ 28MM GEAR OIL SPOUT AND CAGE JJP_PAK035 PG 19
<p>28MM AUTOMOTIVE / INDUSTRIAL JJP_PAK021</p>  <p>●</p> <ul style="list-style-type: none"> ⊘ 28mm 🔩 Screw 📐 Round 🌿 HDPE, Glossy 🗑️ ExPE Liner 	<p>28MM GEAR OIL WITH SPIGOT JJP_PAK030</p>  <p>●</p> <ul style="list-style-type: none"> ⊘ 28mm 🔩 Screw 📐 Round 🌿 HDPE, Glossy 🗑️ Spigot 	<p>38MM AUTOMOTIVE "LITE" CLOSURE JJP_PAK156</p>  <p>● ● ●</p> <ul style="list-style-type: none"> ⊘ 38mm 🔩 Screw 📐 Round 🌿 HDPE, Glossy 🗑️ IHS Liner 	<p>2L FOAM BATH CLOSURE JJP_GEN170</p>  <p>○</p> <ul style="list-style-type: none"> ⊘ 28mm Umbrella 🔩 Screw 📐 Round, Dome 🌿 PP, Glossy 🗑️ Frustum 	<p>28MM GEAR OIL SPOUT AND CAGE JJP_PAK035</p>  <p>○</p> <ul style="list-style-type: none"> ⊘ 28mm GO 🗑️ N/A 📐 Round 🌿 HDPE 🗑️ N/A 	









⊘ NECK DIAMETER 🗑️ NECK TYPE 📐 SHAPE 🌿 MATERIAL 🗑️ CLOSURE / ○ STANDARD COLOUR OPTIONS AVAILABLE

<p>38/400 CLOSURE JJP_GEN123</p>  <ul style="list-style-type: none"> ⊘ 38mm 🔩 38/400, Screw 📏 Round 🌀 PP, Ribbed, Smooth 📏 Liner, Top seal <p style="text-align: right;">①</p>	<p>50/400 CLOSURE JJP_GEN148</p>  <ul style="list-style-type: none"> ⊘ 50mm 🔩 50/400, Screw 📏 Round 🌀 PP, Ribbed, Smooth 📏 Liner <p style="text-align: right;">②</p>	<p>24/400 CLOSURE JJP_GEN151</p>  <ul style="list-style-type: none"> ⊘ 24mm 🔩 24/400, Screw 📏 Round 🌀 PP, Ribbed, Matt 📏 Frustum <p style="text-align: right;">④</p>	<p>18/400 CLOSURE JJP_GEN141</p>  <ul style="list-style-type: none"> ⊘ 18mm 🔩 18/400, Screw 📏 Round 🌀 PP, Ribbed, Matt 📏 Frustum <p style="text-align: right;">⑥</p>	<p>24MM TEAR OFF CAP JJP_GEN127</p>  <ul style="list-style-type: none"> ⊘ 24mm 🔩 Tear off 📏 Round 🌀 LDPE, Smooth 📏 Frustum <p style="text-align: right;">③</p>	<p>RELATED PRODUCTS</p> <p>JARS</p> <ul style="list-style-type: none"> ① 50G PET JELLY CLEAR PLA_S080SSC010 PG 14 ② 100G PET JELLY CLEAR PLA_S081SSC010 PG 14 ③ 25ML VIAL PET CLEAR PLA_S044STC01 PG 14 <p>BOTTLES</p> <ul style="list-style-type: none"> ④ 200ML SHOULDER BOTTLE PLA_S077SSC01 PG 9 ⑤ 100ML SHOULDER BOTTLE PLA_S076SSC01 PG 9 ⑥ 50ML SHOULDER BOTTLE PLA_S075SSC01 PG 9 <p>TUBS</p> <ul style="list-style-type: none"> ⑦ 1KG TUB MAR_A000.1000.12J.W2ZZ.0 PG 16 ⑧ 500G TUB MAR_A000.0500.12I.W1ZZ.0 PG 16 ⑨ 80ML TUB MAR_A000.0080.11E.W0ZZ.0 PG 16
<p>WHITE LID (FOR 1 KG TUB) MAR_A000.0122.82J.B2ZZ.0</p>  <ul style="list-style-type: none"> ⊘ NA 🔩 Clip On Lid, Tamper Evident 📏 Round 🌀 PP, Smooth 📏 Foil, Clip on Lid, Tamper Evident <p style="text-align: right;">⑦</p>	<p>WHITE LID (FOR 500G TUB) MAR_A000.0090.82I.B1ZZ.0</p>  <ul style="list-style-type: none"> ⊘ NA 🔩 Clip On Lid, Tamper Evident 📏 Round 🌀 PP, Smooth 📏 Foil, Clip on Lid, Tamper Evident <p style="text-align: right;">⑧</p>	<p>70MM DOME LID (FOR 80ML TUB) MAR_A000.0070.93E.W1ZZ.0</p>  <ul style="list-style-type: none"> ⊘ NA 🔩 Clip On 📏 Round 🌀 PP, Smooth 📏 Foil, Clip on Lid <p style="text-align: right;">⑨</p>	<p>70MM FLAT LID (FOR 80ML TUB) MAR_A000.0070.83E.W1ZZ.0</p>  <ul style="list-style-type: none"> ⊘ NA 🔩 Clip On 📏 Round 🌀 PP, Smooth 📏 Foil, Clip on <p style="text-align: right;">⑨</p>	<p>CLEAR LID (FOR 250G PEDESTAL TUB) MAR_A000.0095.83G.W2ZZ.0</p>  <ul style="list-style-type: none"> ⊘ NA 🔩 Clip On 📏 Round 🌀 PP, Smooth 📏 Foil, Clip on Lid <p style="text-align: right;">⑨</p>	











⊘ NECK DIAMETER 🔩 NECK TYPE 📏 SHAPE 🌀 MATERIAL 📏 CLOSURE / ○ STANDARD COLOUR OPTIONS AVAILABLE

<p>45MM TE MEDICAP WHITE LINED JJP_GEN210</p>  <p>④ 45mm ② Screw ② Round ② PP, Ribbed ② Liner</p> <p>① ②</p>	<p>38MM TE MEDICAP WHITE LINED JJP_GEN209</p>  <p>③ 38mm ④ Screw ④ Round ④ PP, Ribbed ④ Frustum</p> <p>③ ④</p>	<p>16MM PLUG - 4MM ORIFICE JJP_GEN108</p>  <p>⑤ 16mm ⑤ 16mm Plug ⑤ Round ⑤ PET / HDPE ⑤ Spigot</p> <p>⑤</p>	<p>12MM PLUG - 4MM ORIFICE JJP_GEN107</p>  <p>⑥ 12mm ⑥ 12mm Plug ⑥ Round ⑥ PET / HDPE ⑥ Spigot</p> <p>⑥</p>	<p>12MM PLUG - 4MM ORIFICE LIP JJP_GEN117</p>  <p>⑥ 12mm ⑥ 12mm Plug ⑥ Round / Lip ⑥ PET / HDPE ⑥ Spigot</p> <p>⑥</p>	<p>RELATED PRODUCTS</p> <p>BOTTLES</p> <p>① 340ML MEDIPAC PZN_B8700S/0001 PG 10</p> <p>② 260ML MEDIPAC PZN_B8699S/0001 PG 10</p> <p>③ 175ML MEDIPAC PZN_B8698S/0001 PG 10</p> <p>④ 145ML MEDIPAC PZN_B8697S/0001 PG 10</p> <p>CLOSURES</p> <p>⑤ 44MM SHOULDER CAP JJP_GEN085 PG 19</p> <p>⑥ 36MM SHOULDER CAP JJP_GEN076 PG 19</p> <p>⑦ 125ML / 250ML LID CON_CON109 PG 22</p> <p>⑧ 50ML CLEAR LID CON_CON368 PG 22</p> <p>JARS</p> <p>⑨ 125ML PW SLIM JAR CON_CON520 PG 12</p> <p>⑩ 250ML JAR CON_CON088 PG 12</p> <p>⑪ 125ML COMBI JAR CON_CON033 PG 22</p> <p>⑫ 50ML CLEAR JAR CON_CON366 PG 13</p> <p>⑬ 50ML COMBI JAR CON_CON367 PG 13</p> <p>⑭ 30ML / 50ML CRYSTAL ROUND JAR CON_CON176 PG 13</p> <p>⑮ 30ML / 50ML CRYSTAL CONVEX JAR CON_CON167 PG 13</p> <p>⑯ 30ML / 50ML CRYSTAL SQUARE JAR CON_CON174 PG 13</p> <p>⑰ 30ML / 50ML SLIMLINE CRYSTAL JAR CON_CON378 PG 13</p> <p>⑱ 10ML CLEAR JAR JJP_GEN109 PG 14</p>
<p>125ML / 250ML SHIVE CON_CON116</p>  <p>⑦ 84mm ⑨ Screw ⑩ Round ⑪ LDPE, Smooth ⑪ NA</p> <p>⑦ ⑨ ⑩ ⑪</p>	<p>30ML / 50ML SHIVE CON_CON190</p>  <p>⑭ 30mm / 50mm ⑮ NA ⑯ Round ⑰ HDPE / PP, Smooth ⑰ Shive</p> <p>⑭ ⑮ ⑯ ⑰</p>	<p>50ML SHIVE CON_CON389</p>  <p>⑧ 57.5mm ⑫ NA ⑬ Round ⑬ LDPE, Smooth ⑬ NA</p> <p>⑧ ⑫ ⑬</p>	<p>30ML / 50ML APPLICATOR SHIVE CON_CON191</p>  <p>⑭ 54mm ⑮ N/A ⑯ Round ⑰ HDPE, PP, Smooth ⑰ Applicator shive</p> <p>⑭ ⑮ ⑯ ⑰</p>	<p>33MM SCREW ON CLOSURE JJP_GEN073</p>  <p>⑱ 33mm ⑱ Screw ⑱ Round ⑱ PP ⑱ Frustum</p> <p>⑱</p>	

④ NECK DIAMETER ② NECK TYPE ② SHAPE ② MATERIAL ② CLOSURE / ② STANDARD COLOUR OPTIONS AVAILABLE

<p>250ML / 500ML NT LID CON_CON342 (WHITE) CON_CON353 (CLEAR)</p>  <p>● ○</p> <p>⌀ 88mm (9) (19) 🔩 Screw 📏 Round 🌀 PP, Smooth 🗑️ NA</p>	<p>250ML / 500ML LID CON_CON531 (WHITE) CON_CON130 (CLEAR)</p>  <p>● ○</p> <p>⌀ 97mm (10) 🔩 Screw 📏 Round 🌀 PP, Smooth 🗑️ NA</p>	<p>125ML / 250ML LID CON_CON109 (WHITE) CON_CON103 (CLEAR)</p>  <p>● ○</p> <p>⌀ 84mm (11) (12) (13) (18) 🔩 Screw 📏 Round 🌀 PP, Smooth 🗑️ NA</p>	<p>125ML LID CON_CON060 (WHITE) CON_CON051 (CLEAR)</p>  <p>● ○</p> <p>⌀ 72.5mm (14) 🔩 Screw 📏 Round 🌀 PP, Smooth 🗑️ NA</p>	<p>RELATED PRODUCTS</p> <table border="0"> <thead> <tr> <th colspan="2">JARS</th> <th colspan="2">CLOSURES</th> </tr> </thead> <tbody> <tr> <td>① 30ML / 50ML CRYSTAL ROUND JAR CON_CON176</td> <td>PG 13</td> <td>⑩ 50ML SHIVE CON_CON389</td> <td>PG 21</td> </tr> <tr> <td>② 30ML / 50ML CRYSTAL CONVEX JAR CON_CON167</td> <td>PG 13</td> <td>⑪ 50ML CLEAR LID CON_CON368</td> <td>PG 21</td> </tr> <tr> <td>③ 30ML / 50ML CRYSTAL SQUARE JAR CON_CON174</td> <td>PG 13</td> <td>⑫ 125ML / 250ML SHIVE CON_CON116</td> <td>PG 21</td> </tr> <tr> <td>④ 30ML / 50ML SLIMLINE CRYSTAL JAR CON_CON378</td> <td>PG 13</td> <td></td> <td></td> </tr> <tr> <td>⑤ 50ML INNER JAR CON_CON153</td> <td>PG 13</td> <td></td> <td></td> </tr> <tr> <td>⑥ 30ML INNER JAR CON_CON151</td> <td>PG 13</td> <td></td> <td></td> </tr> <tr> <td>⑦ 50ML CLEAR JAR CON_CON366</td> <td>PG 13</td> <td></td> <td></td> </tr> <tr> <td>⑧ 50ML COMBI JAR CON_CON367</td> <td>PG 13</td> <td></td> <td></td> </tr> <tr> <td>⑨ 250ML NT JAR CON_CON336</td> <td>PG 12</td> <td></td> <td></td> </tr> <tr> <td>⑩ 250ML CLEAR SLIM JAR CON_CON092</td> <td>PG 12</td> <td></td> <td></td> </tr> <tr> <td>⑪ 125ML PW SLIM JAR CON_CON520</td> <td>PG 12</td> <td></td> <td></td> </tr> <tr> <td>⑫ 250ML JAR CON_CON088</td> <td>PG 12</td> <td></td> <td></td> </tr> <tr> <td>⑬ 125ML COMBI JAR CON_CON033</td> <td>PG 13</td> <td></td> <td></td> </tr> <tr> <td>⑭ 125ML JAR CON_CON044</td> <td>PG 12</td> <td></td> <td></td> </tr> <tr> <td>⑮ 125ML NT JAR CON_CON332</td> <td>PG 12</td> <td></td> <td></td> </tr> <tr> <td>⑯ 500ML NT JAR CON_CON340</td> <td>PG 12</td> <td></td> <td></td> </tr> </tbody> </table>	JARS		CLOSURES		① 30ML / 50ML CRYSTAL ROUND JAR CON_CON176	PG 13	⑩ 50ML SHIVE CON_CON389	PG 21	② 30ML / 50ML CRYSTAL CONVEX JAR CON_CON167	PG 13	⑪ 50ML CLEAR LID CON_CON368	PG 21	③ 30ML / 50ML CRYSTAL SQUARE JAR CON_CON174	PG 13	⑫ 125ML / 250ML SHIVE CON_CON116	PG 21	④ 30ML / 50ML SLIMLINE CRYSTAL JAR CON_CON378	PG 13			⑤ 50ML INNER JAR CON_CON153	PG 13			⑥ 30ML INNER JAR CON_CON151	PG 13			⑦ 50ML CLEAR JAR CON_CON366	PG 13			⑧ 50ML COMBI JAR CON_CON367	PG 13			⑨ 250ML NT JAR CON_CON336	PG 12			⑩ 250ML CLEAR SLIM JAR CON_CON092	PG 12			⑪ 125ML PW SLIM JAR CON_CON520	PG 12			⑫ 250ML JAR CON_CON088	PG 12			⑬ 125ML COMBI JAR CON_CON033	PG 13			⑭ 125ML JAR CON_CON044	PG 12			⑮ 125ML NT JAR CON_CON332	PG 12			⑯ 500ML NT JAR CON_CON340	PG 12		
JARS		CLOSURES																																																																						
① 30ML / 50ML CRYSTAL ROUND JAR CON_CON176	PG 13	⑩ 50ML SHIVE CON_CON389	PG 21																																																																					
② 30ML / 50ML CRYSTAL CONVEX JAR CON_CON167	PG 13	⑪ 50ML CLEAR LID CON_CON368	PG 21																																																																					
③ 30ML / 50ML CRYSTAL SQUARE JAR CON_CON174	PG 13	⑫ 125ML / 250ML SHIVE CON_CON116	PG 21																																																																					
④ 30ML / 50ML SLIMLINE CRYSTAL JAR CON_CON378	PG 13																																																																							
⑤ 50ML INNER JAR CON_CON153	PG 13																																																																							
⑥ 30ML INNER JAR CON_CON151	PG 13																																																																							
⑦ 50ML CLEAR JAR CON_CON366	PG 13																																																																							
⑧ 50ML COMBI JAR CON_CON367	PG 13																																																																							
⑨ 250ML NT JAR CON_CON336	PG 12																																																																							
⑩ 250ML CLEAR SLIM JAR CON_CON092	PG 12																																																																							
⑪ 125ML PW SLIM JAR CON_CON520	PG 12																																																																							
⑫ 250ML JAR CON_CON088	PG 12																																																																							
⑬ 125ML COMBI JAR CON_CON033	PG 13																																																																							
⑭ 125ML JAR CON_CON044	PG 12																																																																							
⑮ 125ML NT JAR CON_CON332	PG 12																																																																							
⑯ 500ML NT JAR CON_CON340	PG 12																																																																							
<p>125ML NT LID CON_CON345 (WHITE) CON_CON350 (CLEAR)</p>  <p>● ○</p> <p>⌀ 72mm (15) 🔩 Screw 📏 Round 🌀 PP, Smooth 🗑️ NA</p>	<p>CRYSTAL JAR FLAT LID CON_CON432</p>  <p>●</p> <p>① NA ② Screw ③ Round ④ PP, Smooth ⑤ Shive ⑥</p>	<p>50ML CRYSTAL JAR WHITE LID CON_CON183</p>  <p>●</p> <p>① 54mm ② Screw ③ Round ④ PP, Smooth ⑤ Shive ⑥</p>	<p>50ML CLEAR LID CON_CON368</p>  <p>○</p> <p>⑦ 57.5mm ⑧ Screw ⑨ Round ⑩ PP, Smooth ⑪ NA</p>																																																																					

⌀ NECK DIAMETER 🔩 NECK TYPE 📏 SHAPE 🌀 MATERIAL 🗑️ CLOSURE / ● ○ STANDARD COLOUR OPTIONS AVAILABLE









<p>500G GREASE LID JJP_PAK091</p>  <p>● ● ● ●</p> <ul style="list-style-type: none"> ⊗ 95mm ⌘ Screw ⌘ Round ⌘ PP, Glossy with Ribs ⌘ None, ExPE Option <p style="text-align: right;">①</p>	<p>500G TUB LID RPC_GN0019</p>  <p>●</p> <ul style="list-style-type: none"> ⊗ NA ⌘ Clip on Lid ⌘ Round ⌘ NA, Smooth ⌘ Clip <p style="text-align: right;">②</p>	<p>DROPPER CAP JJP_GEN173</p>  <p>● ●</p> <ul style="list-style-type: none"> ⊗ 13mm ⌘ Screw Cap ⌘ Round Peak ⌘ HDPE, Ribbed ⌘ Frustum <p style="text-align: right;">③ ④ ⑤</p>	<p>DROPPER PLUG JJP_GEN184</p>  <p>○</p> <ul style="list-style-type: none"> ⊗ 13mm ⌘ NA ⌘ Round ⌘ LDPE, Glossy ⌘ NA <p style="text-align: right;">③ ④ ⑥</p>	<p>32MM CLOSURE RPC_GN0021</p>  <p>○</p> <ul style="list-style-type: none"> ⊗ 32mm ⌘ Screw ⌘ Round ⌘ SAN, Glossy ⌘ Frustum 	<p>RELATED PRODUCTS</p> <p>TUBS</p> <p>① 500G GREASE TUB JJP_PAK099 PG 16</p> <p>② 500G TUB RPC_GN0018 PG 17</p> <p>BOTTLES</p> <p>③ 5ML DROPPER BOTTLE PZN_B8695S/0002 PG 10</p> <p>④ 15ML DROPPER BOTTLE PZN_B8695S/0001 PG 10</p> <p>CLOSURES</p> <p>⑤ DROPPER PLUG JJP_GEN184 PG 23</p> <p>⑥ DROPPER CAP JJP_GEN173 PG 23</p>
<p>40MM CLIP ON LID RPC_GN0022</p>  <p>○</p> <ul style="list-style-type: none"> ⊗ 40mm ⌘ Clip on Lid ⌘ Round ⌘ NA, Glossy ⌘ Clip 	<p>24MM GLUE SPOUT CLOSURE RPC_GN0023</p>  <p>●</p> <ul style="list-style-type: none"> ⊗ 24mm ⌘ Screw ⌘ Round, Spout ⌘ NA, Glossy ⌘ Frustum 	<p>DUST COVER 65MM MAR_GEN212</p>  <p>●</p> <ul style="list-style-type: none"> ⊗ 65mm ⌘ Clip on ⌘ Round with square shoulder ⌘ PP, Glossy ⌘ NA 	<p>DUST COVER 57MM MAR_GEN211</p>  <p>●</p> <ul style="list-style-type: none"> ⊗ 57mm ⌘ Clip on ⌘ Round with square shoulder ⌘ PP, Glossy ⌘ NA 	<p>DUST COVER 52MM MAR_GEN213</p>  <p>●</p> <ul style="list-style-type: none"> ⊗ 52mm ⌘ Clip on ⌘ Round with square shoulder ⌘ PP, Glossy ⌘ NA 	

⊗ NECK DIAMETER ⌘ NECK TYPE ⌘ SHAPE ⌘ MATERIAL ⌘ CLOSURE / ○ STANDARD COLOUR OPTIONS AVAILABLE



SECTION 5 //

ROLL-ONS

<p>STANDARD 50ML SMALL BALL BOTTLE PZN_B8689S/0004 (SILVER) PZN_B8689S/0012 (WHITE)</p>  <p>● ●</p> <ul style="list-style-type: none"> ⊗ 25mm ⌌ NA ⌌ Round ⊞ PP, Glossy ⌌ NA <p style="text-align: right;">① ②</p>	<p>STANDARD 50ML SMALL BALL CAP DOME JJP_AMK029</p>  <p>● ● ●</p> <ul style="list-style-type: none"> ⊗ 25mm ⌌ Screw Cap ⌌ Round / Dome Shoulder ⊞ PP, Glossy ⌌ NA <p style="text-align: right;">① ③</p>	<p>STANDARD 50ML SMALL BALL JJP_LEV261</p>  <p>○</p> <ul style="list-style-type: none"> ⊗ 25mm ⌌ NA ⌌ Round ⊞ PP, Matt ⌌ NA <p style="text-align: right;">② ③</p>	<p>STANDARD 50ML BIG BALL BOTTLE PZN_B8689S/0003 (BLACK) PZN_B8689S/0008 (WHITE)</p>  <p>● ●</p> <ul style="list-style-type: none"> ⊗ 35mm ⌌ NA ⌌ Round ⊞ PP, Glossy ⌌ NA <p style="text-align: right;">④ ⑤ ⑥</p>	<p>STANDARD 50ML BIG BALL JJP_LEV260</p>  <p>○</p> <ul style="list-style-type: none"> ⊗ 35mm ⌌ NA ⌌ Round ⊞ PP, Matt ⌌ NA <p style="text-align: right;">⑤ ⑥ ⑦</p>	<p>RELATED PRODUCTS ROLL-ONS</p> <ul style="list-style-type: none"> ① STANDARD 50ML SMALL BALL JJP_LEV261 PG 25 ② STANDARD 50ML SMALL BALL CAP DOME JJP_AMK029 PG 25 ③ STANDARD 50ML SMALL BALL BOTTLE PZN_B8689S/0004 PG 25 ④ STANDARD 50ML BIG BALL JJP_LEV260 PG 25 ⑤ STANDARD 50ML BIG BALL CAP DOME JJP_AMK002 PG 25 ⑥ STANDARD 50ML BIG BALL CAP SQUARE JJP_AMK030 PG 25 ⑦ STANDARD 50ML BIG BALL BOTTLE PZN_B8689S/0003 PG 25
<p>STANDARD 50ML BIG BALL CAP DOME JJP_AMK002</p>  <p>● ● ●</p> <ul style="list-style-type: none"> ⊗ 35mm ⌌ Screw Cap ⌌ Round / Dome Shoulder ⊞ PP, Glossy ⌌ NA <p style="text-align: right;">④ ⑦</p>	<p>STANDARD 50ML BIG BALL CAP SQUARE JJP_AMK030</p>  <p>● ● ●</p> <ul style="list-style-type: none"> ⊗ 35mm ⌌ Screw Cap ⌌ Round / Square Shoulder ⊞ PP, Glossy ⌌ NA <p style="text-align: right;">④ ⑦</p>				

⊗ NECK DIAMETER ⌌ NECK TYPE ⌌ SHAPE ⊞ MATERIAL ⌌ CLOSURE / ○ STANDARD COLOUR OPTIONS AVAILABLE

SECTION 6 //

TUBES



MONOLAYER TUBES

Berry Astrapak's tubes can be manufactured as Monolayer or EVOH Multilayer. The type of tube that is manufactured is largely dependent on the type of product that is being packaged. Unless compatibility trials have been conducted on monolayer tubes and found to be successful, we strongly advise that the following products are packaged in Multilayer tubes:

- SPF
- Essential Oils
- Organic Ingredients
- Clear Gel products
(Face Wash, Body Wash, Hand Sanitizers)

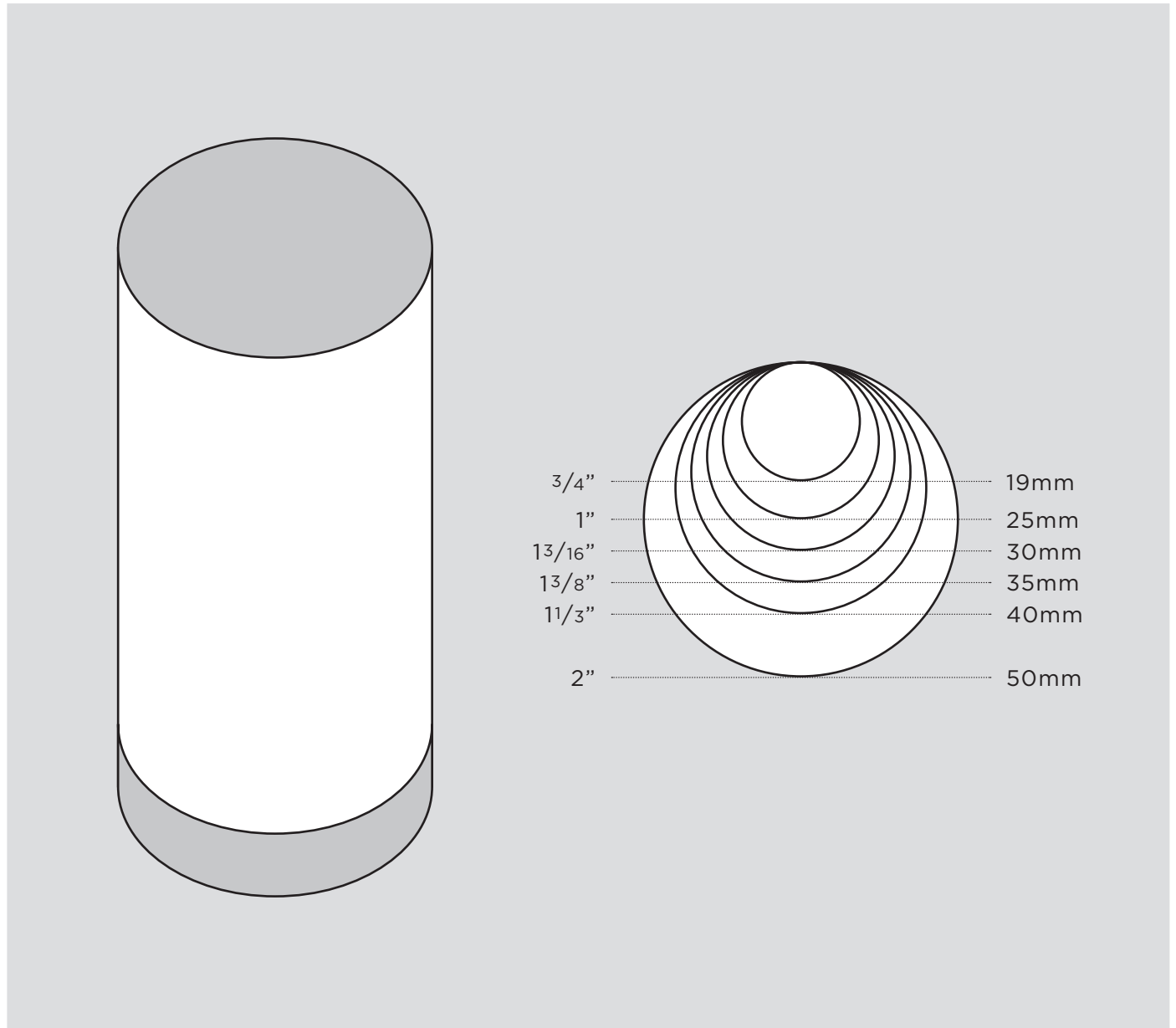

EVOH MULTILAYER TUBES

GAS BARRIER PROPERTIES

EVOH (Ethylene Vinyl Alcohol) resins offer outstanding gas barrier properties, which are superior to those of any other conventional polymer. Food quality generally deteriorates due to the presence of oxygen, EVOH effectively enhances flavour and quality retention by preventing oxygen from penetrating through the package.

RESISTANCE TO OIL AND ORGANIC SOLVENTS

EVOH's resistance to oils and organic solvents is very good. EVOH is therefore suitable for packaging oily foods, edible oils, mineral oils, agricultural pesticides and organic solvents.

AROMA AND FLAVOUR PRESERVATION

EVOH based packaging is effective in retaining fragrances and preserving the aroma and flavour of the contents within the package for the desired period of time. At the same time, undesirable odours are prevented from entering the packaging.

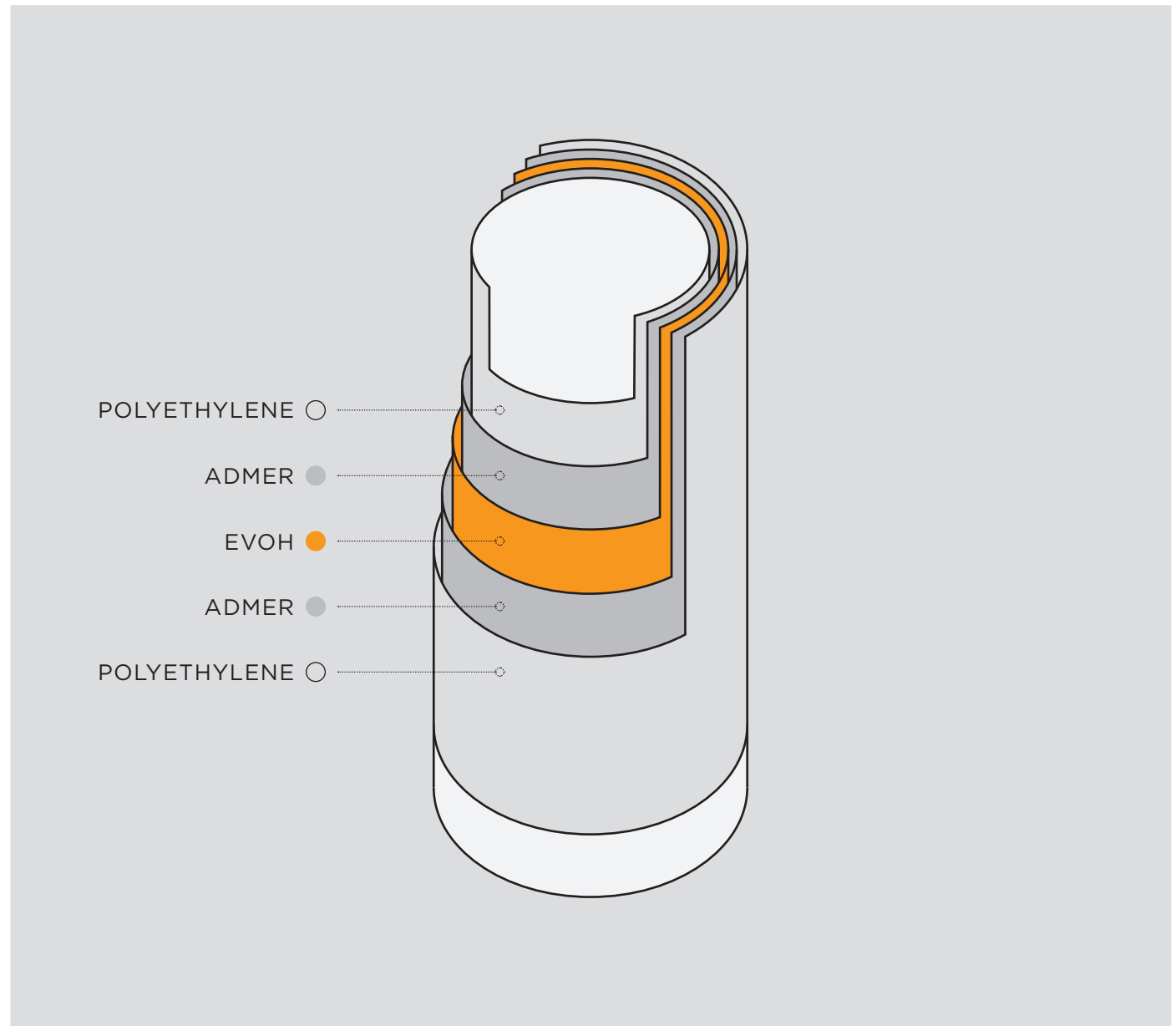

PRODUCT VOLUME FOR SNAP ON TUBES

Use the guides below to work out the length and diameter tube that you require for your volume of product.

Tube diameter is set, the length of tubing can be adjusted.

These values are approximates only.

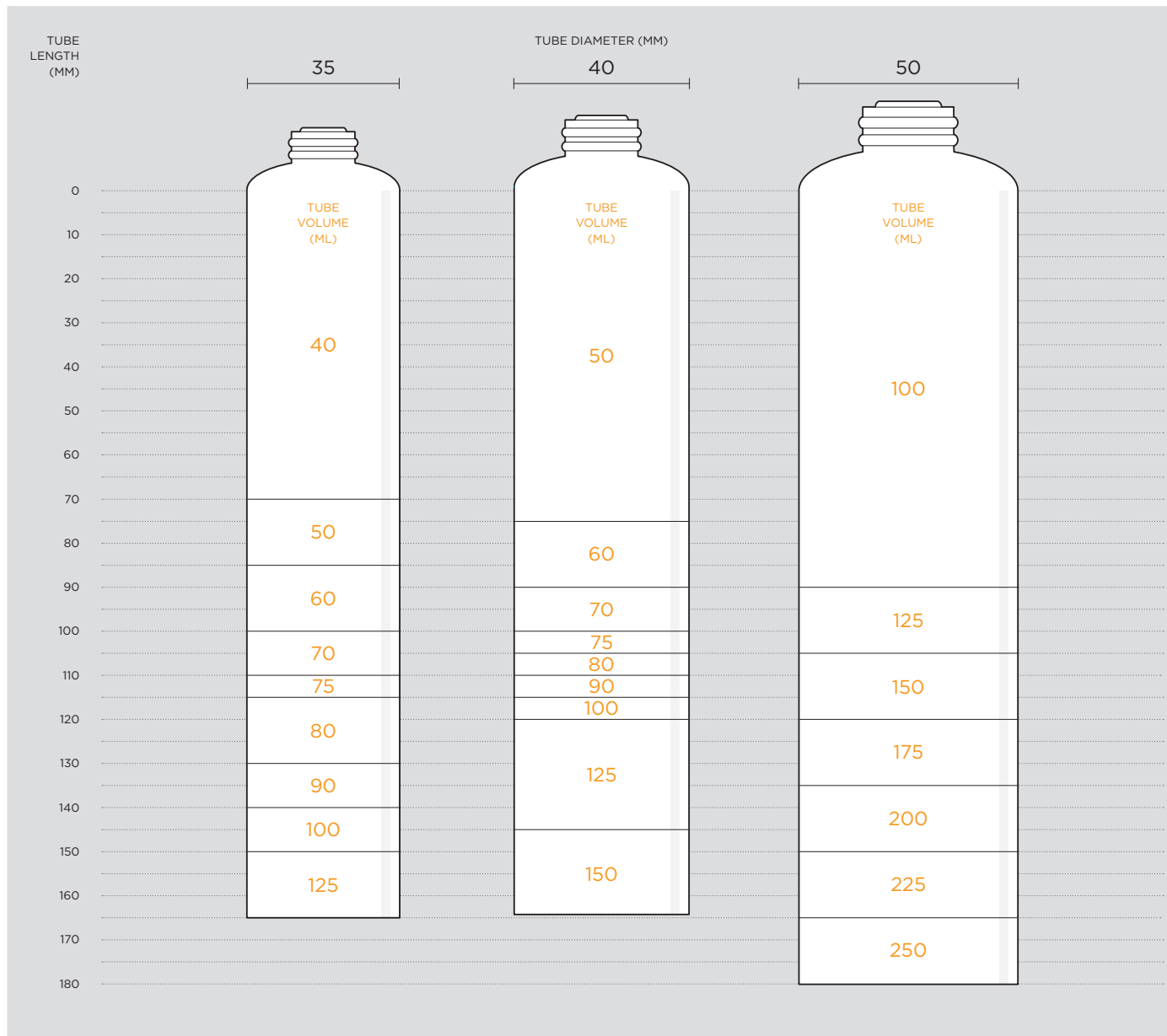

PRODUCT VOLUME FOR SCREW ON TUBES

Use the guides below to work out the length and diameter tube that you require for your volume of product.

Tube diameter is set, the length of tubing can be adjusted.

These values are approximates only.

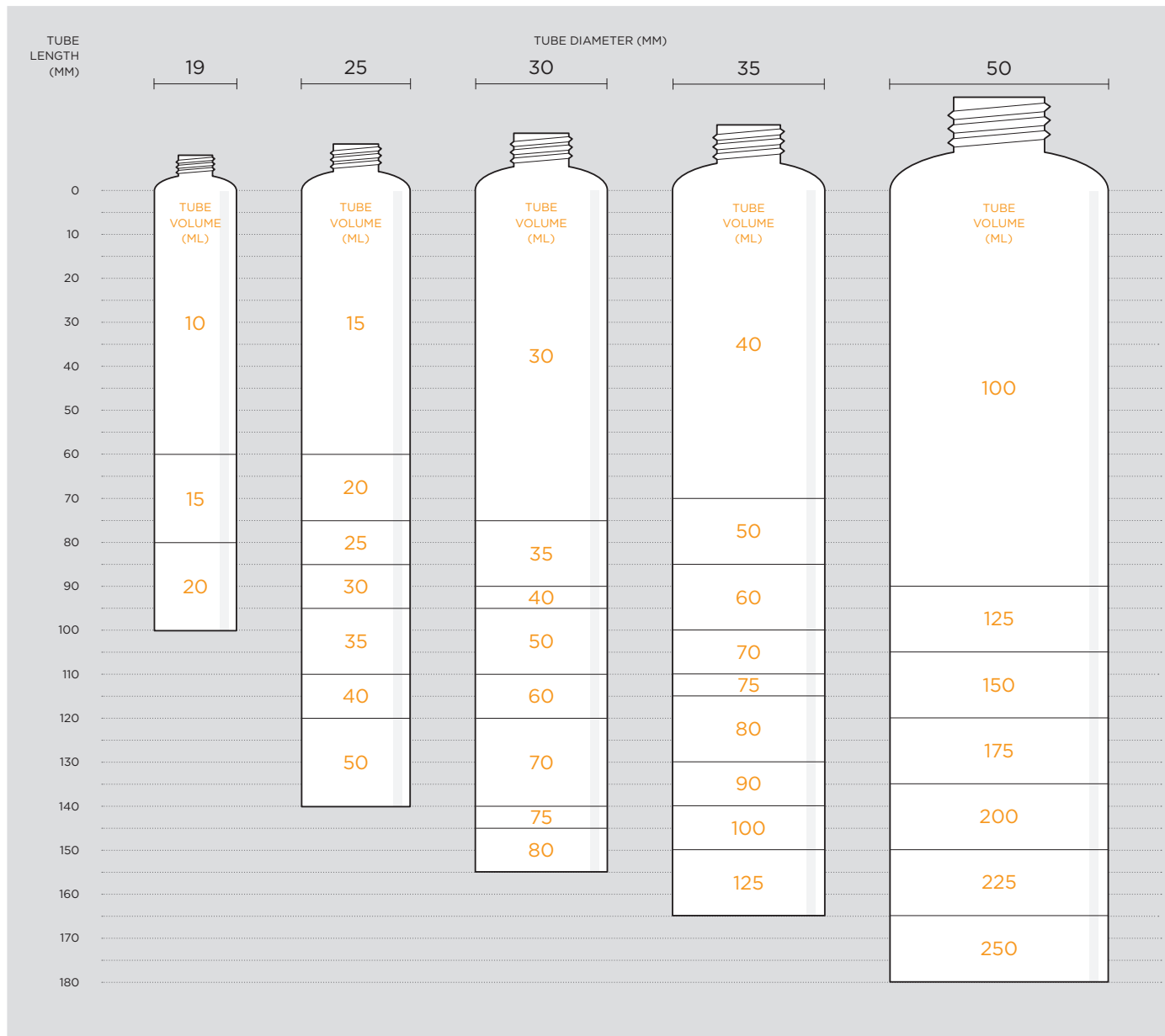

PRODUCT VOLUME FOR OVAL TUBES

Use the guides below to work out the length and diameter tube that you require for your volume of product.

Tube diameter is set, the length of tubing can be adjusted.

These values are approximates only.

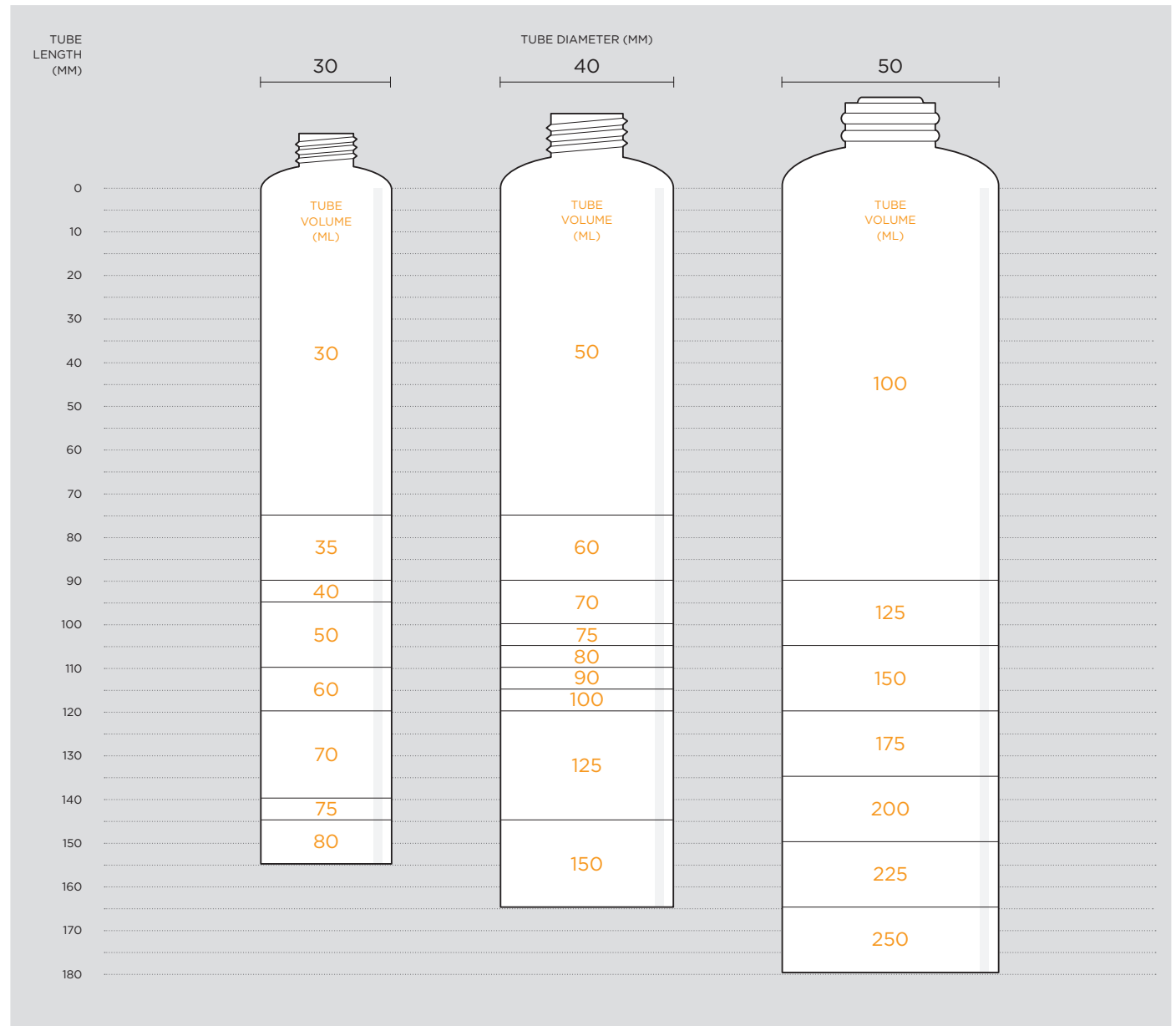

TUBE & CAP SPECIFICATIONS



TUBE & CAP SPECIFICATIONS



FEATURES

Available in many different sizes with a multitude of decorative options. Berry Astrapak's range of tubes combine aesthetic appeal with functionality. Available in mono layer, 2 layer or 5 layer (including EVOH) configurations. Berry Astrapak tubes can be used in the most demanding applications.

1. TAMPER-EVIDENT BANDS

ON ALL FLIP-TOP CAPS

Offers retailers and consumers ultimate protection against in-store browsing and tampering.

2. DECORATIVE FOILING ON CAPS

AND TUBES

Caps and tubes can be foiled on circumference to enhance product image.

3. VARIETY OF VARNISHES

To provide matt/gloss appearance and varied textures for feel.

4. ALIGNMENT OF FLIP-TOP CAPS

WITH FRONT PANEL OF TUBE

Provides for excellent on-shelf presentation and user-friendly orientation.

5. LABELLING

Accurate patch and wrap around labelling ensures the most demanding designs can be used on tubes.

6. ABILITY TO PRINT IN CMYK

Provides more flexible options for design.

7. MULTI-COLOUR SCREEN

PRINT DECORATION

Features bold, accurately aligned colour decoration.

8. FOIL SEALS ON ALL SCREW TOP TUBES

Ensures integrity of product to end-users.

9. SPECIAL APPLICATIONS

Add consumer appeal and ease of use.

10. EXTRUDED TUBE BODY

Consistent wall thickness for uniform feel and quality printing.

11. HIGH-TECH IN-HOUSE

QUALITY INSPECTION





Ensures product conforms consistently to the most stringent international specifications.

12. STATE-OF-THE-ART MANUFACTURING AND

DECORATING TECHNOLOGY Allows for efficient production runs of all sizes from a minimum of 5000 units to large, continuous runs.

WORKSMAP FOR 19MM DIAMETER TUBE

WORKSMAP KEY

-  NO PRINT AREA
-  VISIBLE FRONT AND BACK
-  POSSIBLE PRINT AREA
-  PRINT AREA DEPENDENT ON SEALING EQUIPMENT

LENGTH	CAPACITY
100mm	20ml
90mm	
80mm	15ml
70mm	
60mm	10ml

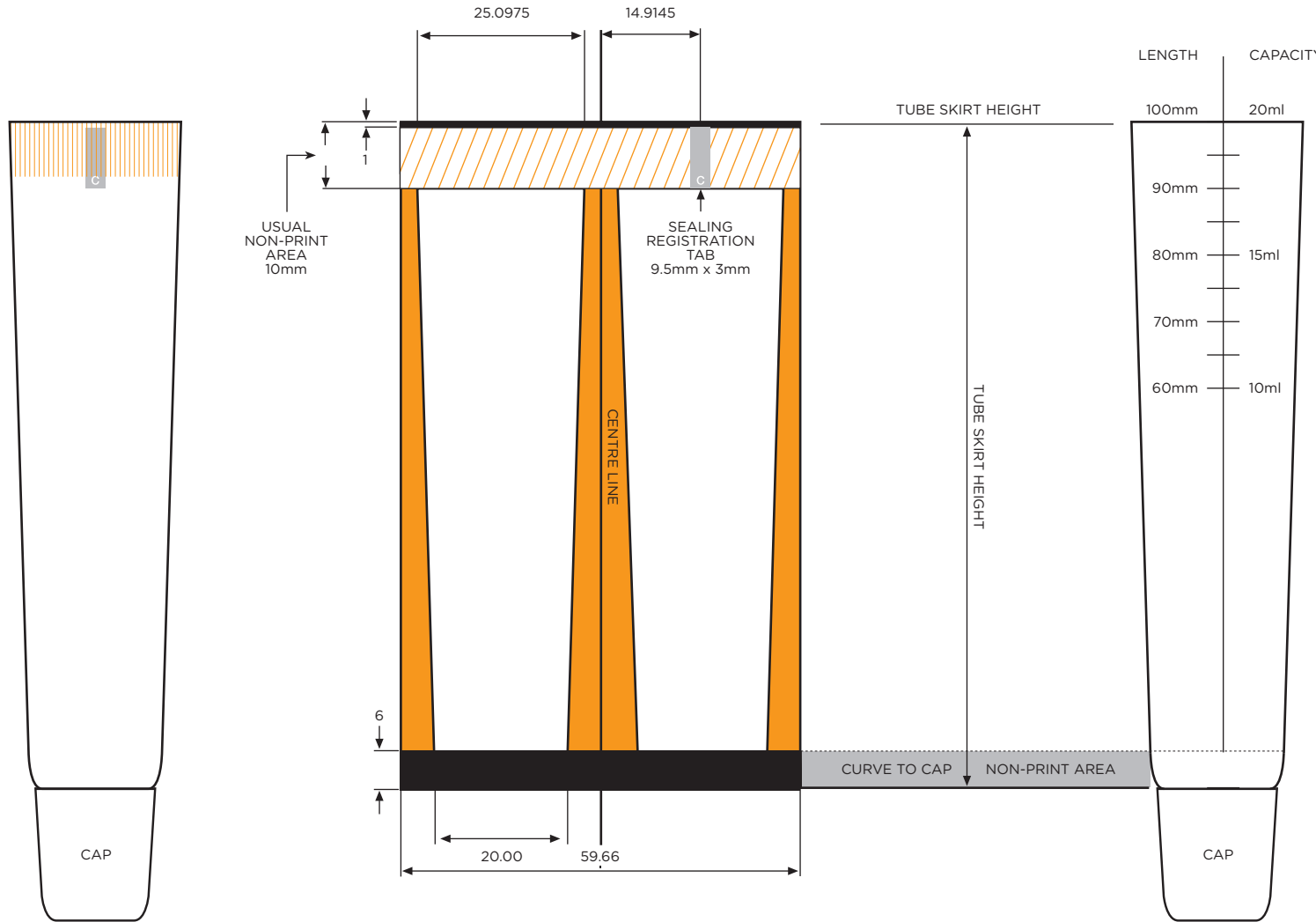

WORKSMAP FOR 25MM DIAMETER TUBE

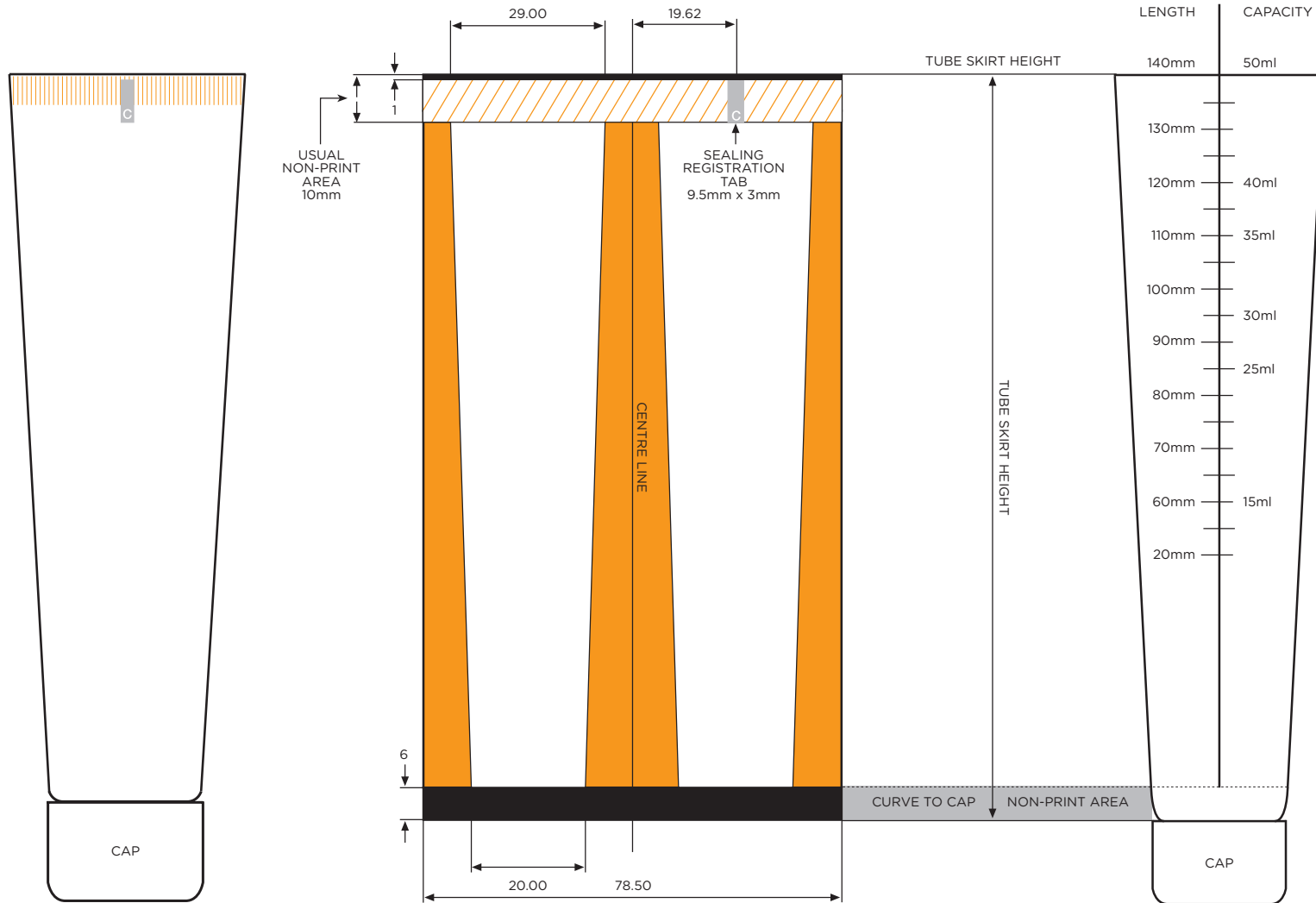

WORKSMAP KEY

- NO PRINT AREA
- VISIBLE FRONT AND BACK
- POSSIBLE PRINT AREA
- PRINT AREA DEPENDENT ON SEALING EQUIPMENT

WORKSMAP FOR 30MM DIAMETER TUBE

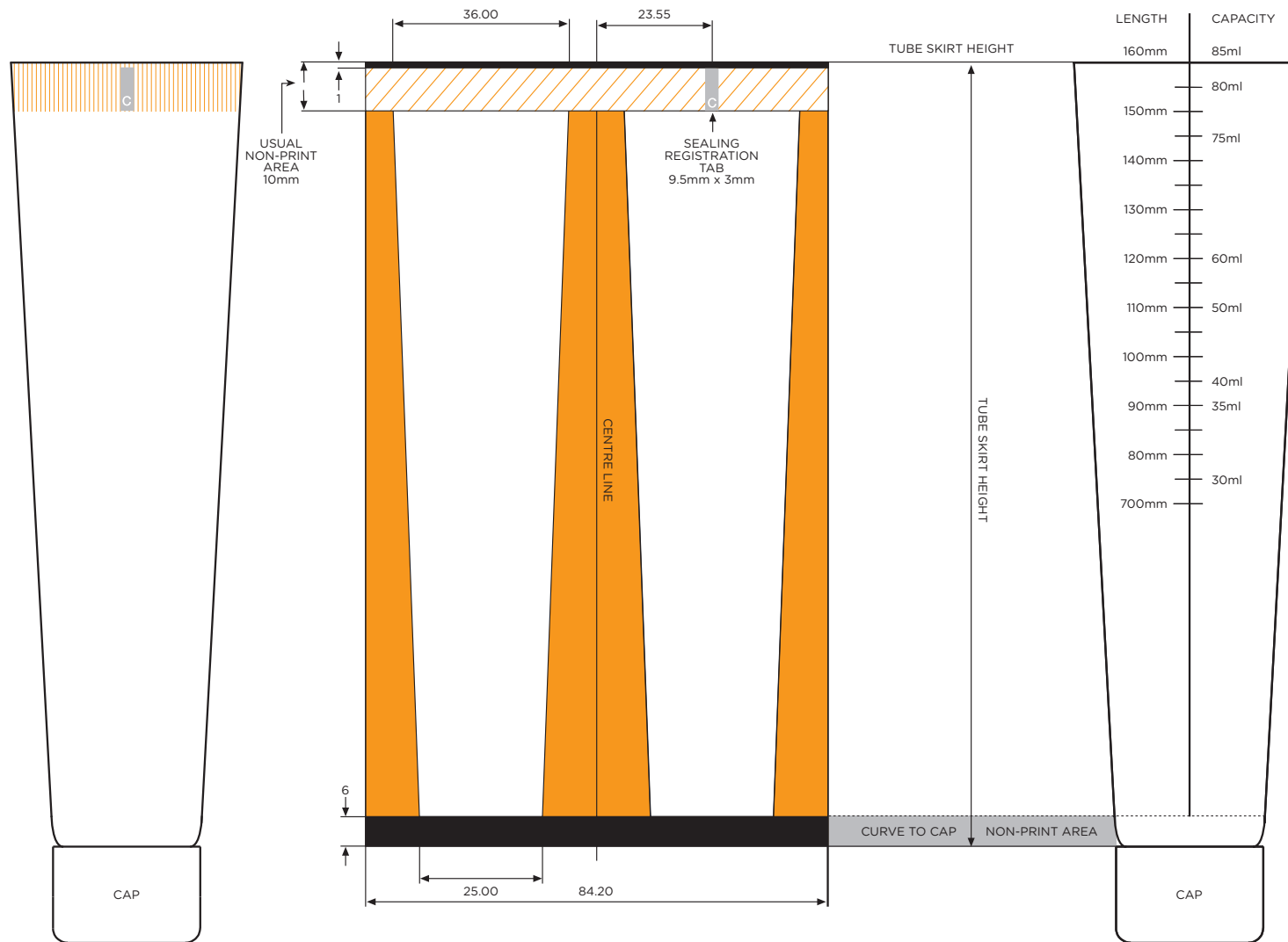

WORKSMAP KEY

- NO PRINT AREA
- VISIBLE FRONT AND BACK
- POSSIBLE PRINT AREA
- PRINT AREA DEPENDENT ON SEALING EQUIPMENT

WORKSMAP FOR 35MM DIAMETER TUBE

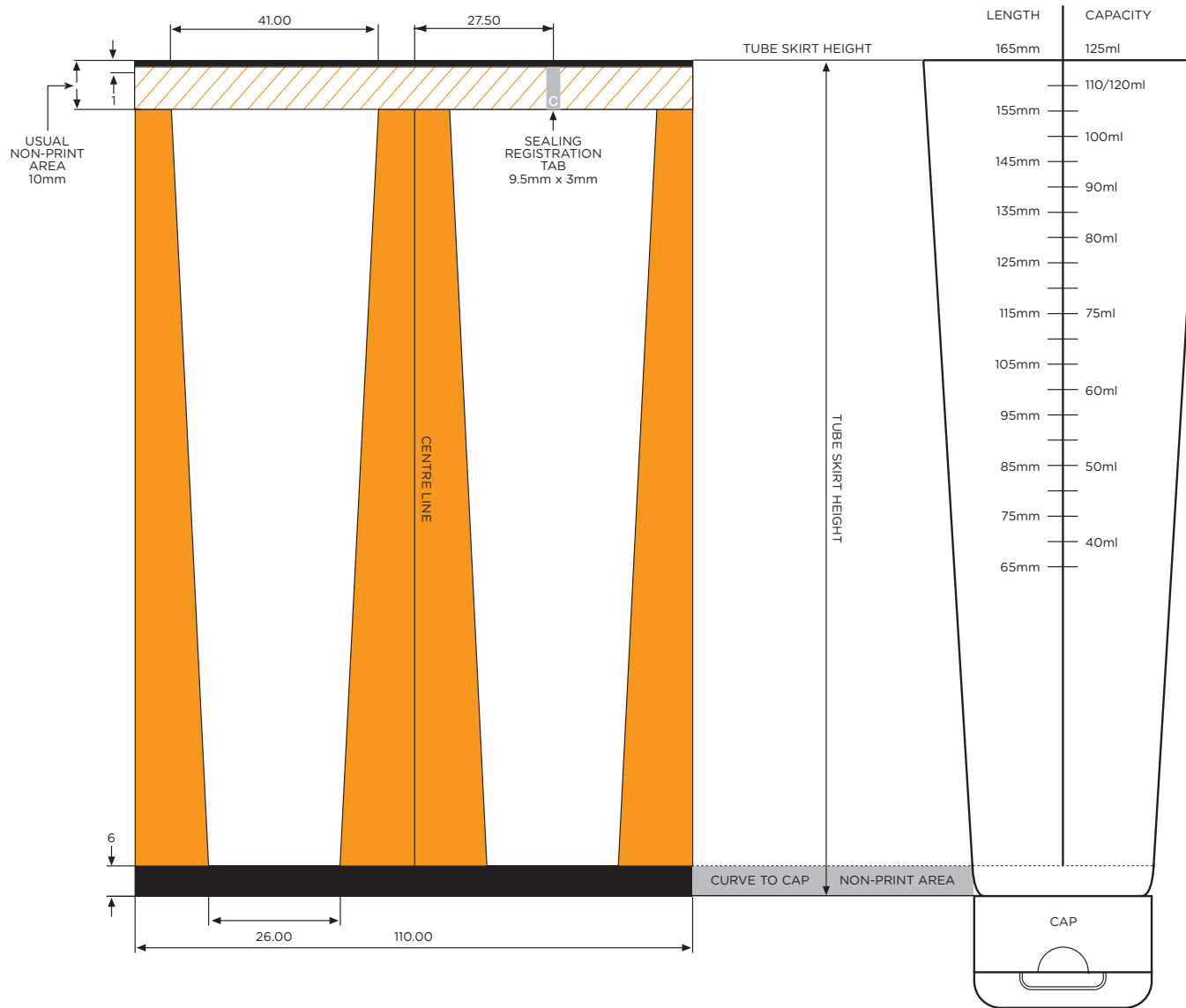

WORKSMAP KEY

- NO PRINT AREA
- VISIBLE FRONT AND BACK
- POSSIBLE PRINT AREA
- PRINT AREA DEPENDENT ON SEALING EQUIPMENT

WORKSMAP FOR 40MM DIAMETER TUBE

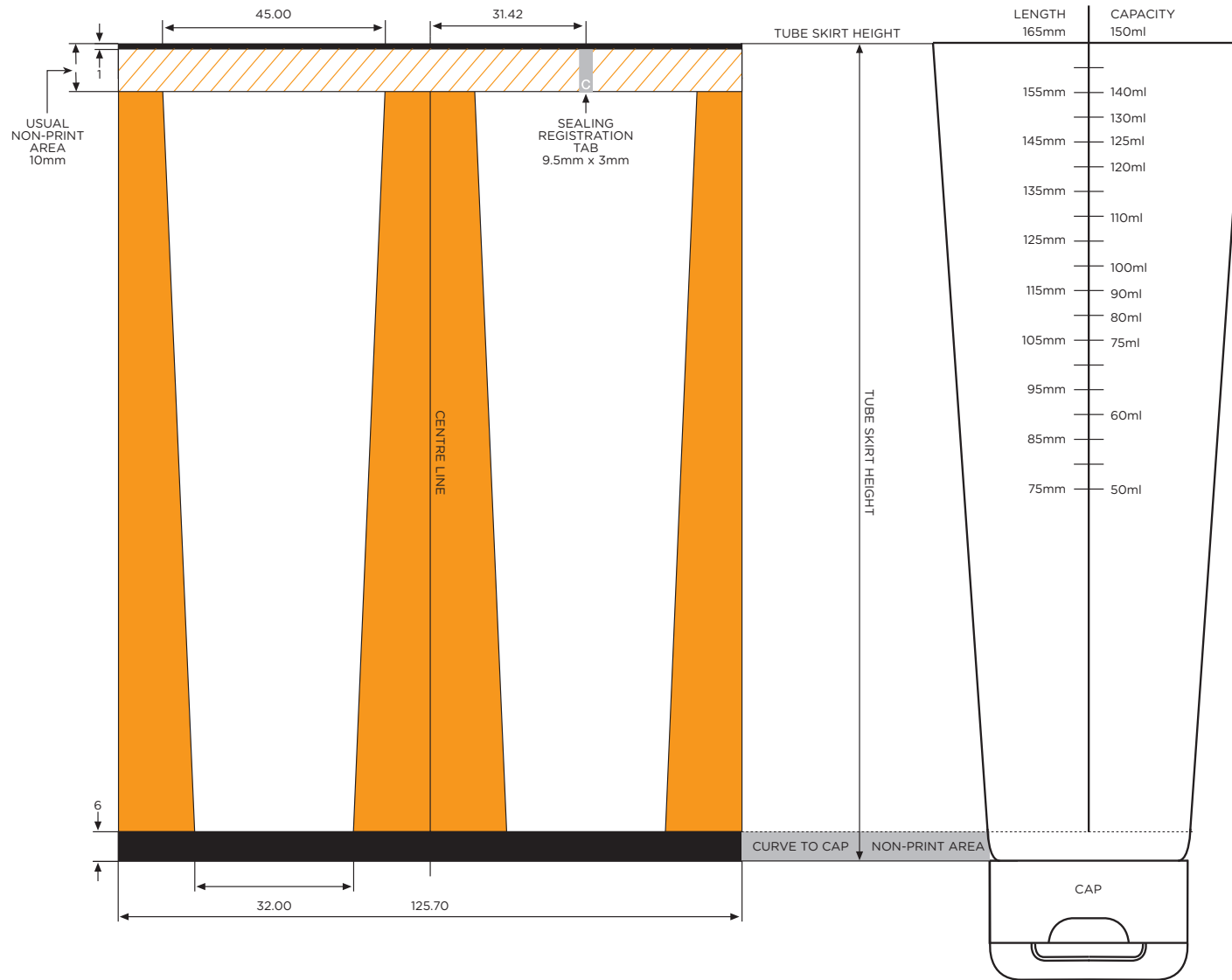



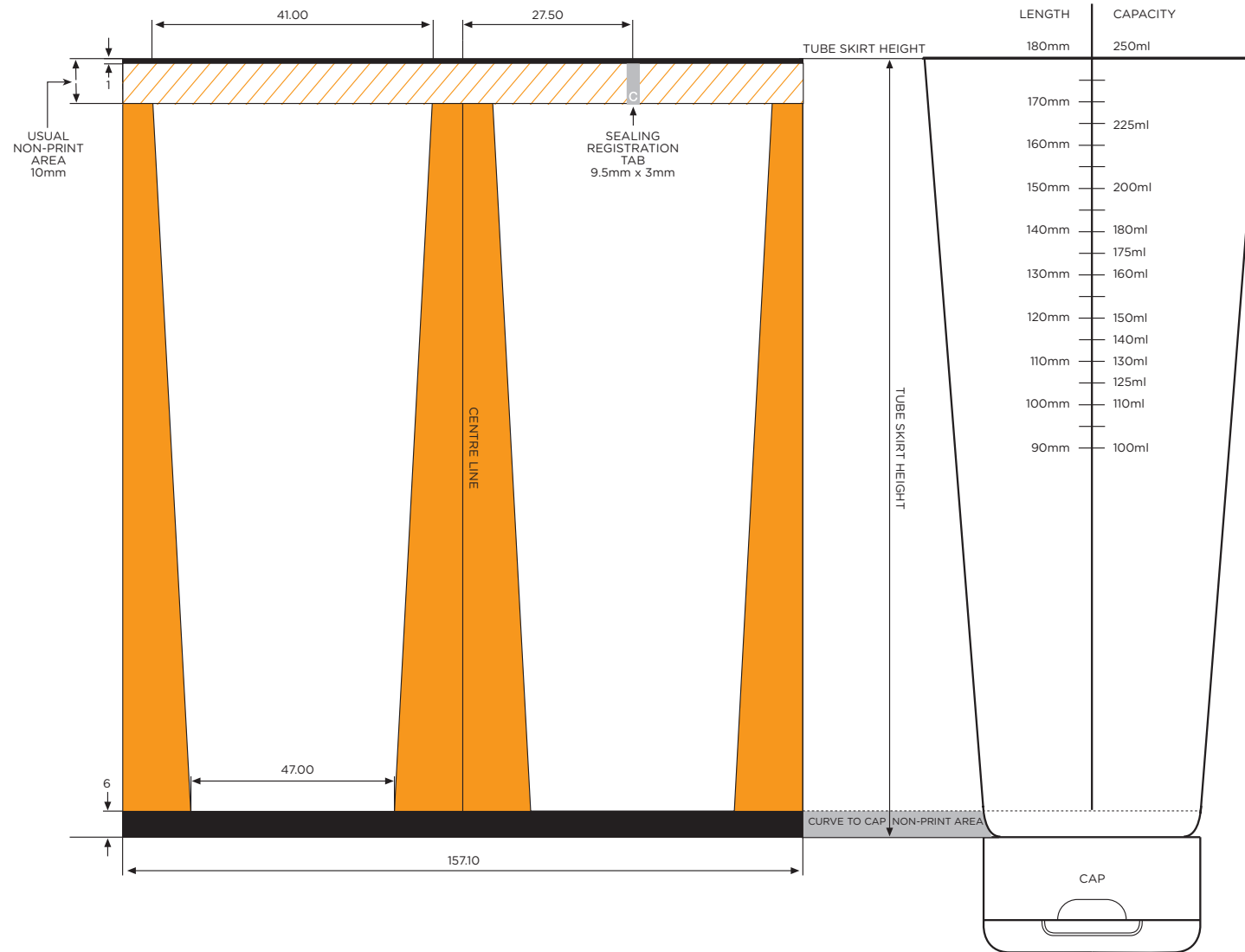

WORKSMAP KEY

- NO PRINT AREA
- VISIBLE FRONT AND BACK
- POSSIBLE PRINT AREA
- PRINT AREA DEPENDENT ON SEALING EQUIPMENT

WORKSMAP FOR 50MM DIAMETER TUBE



WORKSMAP KEY

-  NO PRINT AREA
-  VISIBLE FRONT AND BACK
-  POSSIBLE PRINT AREA
-  PRINT AREA DEPENDENT ON SEALING EQUIPMENT

19MM DROPPER TUBE SCREW ON

RPC_GN0001



- ⊘ 15mm
 - 🔩 Screw
 - 📏 Round
 - 🌀 LD / Co Ex, Smooth
 - 📦 19mm Screw Cap
- | | |
|----------------|---|
| 📏 10ml (60mm) | ① |
| 📏 15ml (80mm) | |
| 📏 20ml (100mm) | |

19MM LIP BALM TUBE SCREW ON

RPC_GN0002



- ⊘ 15mm
 - 🔩 Screw
 - 📏 Round
 - 🌀 LD / Co Ex, Smooth
 - 📦 19mm Screw Cap
- | | |
|----------------|---|
| 📏 10ml (60mm) | ① |
| 📏 15ml (80mm) | |
| 📏 20ml (100mm) | |



RELATED PRODUCTS

CLOSURES

- ① 19MM SCREW CAP
CON_COQ118 PG 43
- ② 25MM SCREW CAP
CON_COQ001 PG 43
- ③ 25MM SCREW ON FLIP TOP NT
CON_COQ828L PG 43
- ④ 30MM SCREW CAP
CON_COQ014 PG 43
- ⑤ 35MM SCREW CAP
CON_COQ021 PG 43

25MM TUBE SCREW ON FOIL SEALED

RPC_GN0003



- ⊘ 15mm
 - 🔩 Screw
 - 📏 Round
 - 🌀 LD / Co Ex, Smooth
 - 📦 25mm Screw Cap, Foil/Plug
- | | |
|----------------|---|
| 📏 15ml (60mm) | ② |
| 📏 20ml (75mm) | ③ |
| 📏 25ml (85mm) | |
| 📏 30ml (95mm) | |
| 📏 35ml (110mm) | |
| 📏 40ml (120mm) | |
| 📏 50ml (140mm) | |

30MM TUBE SCREW ON FOIL SEALED

RPC_GN0004



- ⊘ 15mm
 - 🔩 Screw
 - 📏 Round
 - 🌀 LD / Co Ex, Smooth
 - 📦 25mm Screw Cap
 - 📦 30mm Screw Cap, Foil/Plug
- | | |
|----------------|---|
| 📏 30ml (75mm) | ② |
| 📏 35ml (90mm) | ④ |
| 📏 40ml (95mm) | |
| 📏 50ml (110mm) | |
| 📏 60ml (120mm) | |
| 📏 70ml (140mm) | |
| 📏 75ml (145mm) | |
| 📏 80ml (155mm) | |

35MM TUBE SCREW ON

RPC_GN0005



- ⊘ 15mm / 22mm
 - 🔩 Screw
 - 📏 Round
 - 🌀 LD / Co Ex, Smooth
 - 📦 25mm Screw Cap
 - 📦 30mm Screw Cap
 - 📦 35mm Screw Cap, Foil/Plug
- | | |
|-----------------|---|
| 📏 40ml (70mm) | ② |
| 📏 50ml (85mm) | ④ |
| 📏 60ml (100mm) | ⑤ |
| 📏 70ml (110mm) | |
| 📏 75ml (115mm) | |
| 📏 80ml (130mm) | |
| 📏 90ml (140mm) | |
| 📏 100ml (150mm) | |
| 📏 125ml (165mm) | |

⊘ NECK DIAMETER 🔩 NECK TYPE 📏 SHAPE 🌀 MATERIAL 📦 CLOSURE 📏 VOLUME / ○ STANDARD COLOUR OPTIONS AVAILABLE

35MM TUBE SNAP ON

RPC_GN0006

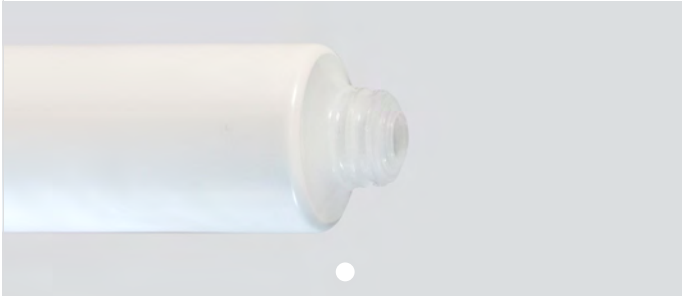

⊘ 15mm / 22mm	📏 40ml (70mm)	100ml (150mm)	①
👤 Snap On	50ml (85mm)	125ml (165mm)	②
📏 Round	60ml (100mm)		
🌀 LD / Co Ex, Smooth	70ml (110mm)		
👤 35mm Snap On	75ml (115mm)		
	80ml (130mm)		
	90ml (140mm)		

40MM TUBE SNAP ON

RPC_GN0007



⊘ 22mm	📏 50ml (75mm)	125ml (145mm)	①
👤 Snap On	60ml (90mm)	150ml (165mm)	②
📏 Round	70ml (100mm)		③
🌀 LD / Co Ex, Smooth	75ml (105mm)		④
👤 35mm Snap On	80ml (110mm)		
👤 40mm Snap On	90ml (115mm)		
	100ml (120mm)		

RELATED PRODUCTS

CLOSURES

- ① 35MM SNAP ON FLIP TOP NT
RPC_GN0034 PG 44
- ② 35MM SNAP ON FLIP TOP TE
CON_COQ028 PG 43
- ③ 40MM SNAP ON FLIP TOP NT
CON_COQ032 PG 44
- ④ 40MM SNAP ON FLIP TOP TE
CON_COQ035 PG 44
- ⑤ 50MM SCREW CAP
CON_COQ803 PG 44
- ⑥ 50MM SNAP ON FLIP TOP NT
CON_COQ236 PG 44
- ⑦ 50MM SNAP ON FLIP TOP TE
CON_COQ042 PG 44
- ⑧ 30MM SCREW ON FLIP TOP
NT OVAL
RPC_GN0031 PG 44

50MM TUBE SCREW ON

RPC_GN0008



⊘ 22mm	📏 100ml (90mm)	⑤
👤 Screw On	125ml (105mm)	
📏 Round	150ml (120mm)	
🌀 LD / Co Ex, Smooth	175ml (135mm)	
👤 50mm Screw Cap, Foil/Plug	200ml (150mm)	
	225ml (165mm)	
	250ml (180ml)	

50MM TUBE SNAP ON

RPC_GN0009



⊘ 22mm	📏 100ml (90mm)	②
👤 Snap On	125ml (105mm)	③
📏 Round	150ml (120mm)	⑥
🌀 LD / Co Ex, Smooth	175ml (135mm)	⑦
👤 35mm Snap On	200ml (150mm)	
👤 40mm Snap On	225ml (165mm)	
👤 50mm Snap On	250ml (180ml)	

30MM TUBE SCREW ON OVAL

RPC_GN0012



⊘ 22mm	📏 30ml (75mm)	80ml (155mm)	⑧
👤 Screw On	35ml (90mm)		
📏 Oval	40ml (95mm)		
🌀 LD/Co Ex, Smooth	50ml (110mm)		
👤 30mm Screw On, Foil/Plug	60ml (120mm)		
	70ml (140mm)		
	75ml (145ml)		

⊘ NECK DIAMETER 👤 NECK TYPE 📏 SHAPE 🌀 MATERIAL 📏 CLOSURE 📏 VOLUME / ○ STANDARD COLOUR OPTIONS AVAILABLE

40MM TUBE SCREW ON OVAL

RPC_GN0013



- ⌀ 22mm
- 🔧 Screw
- 📏 Oval
- 🌀 LD/Co Ex, Smooth
- 📦 40mm Screw On, Foil/Plug
- 📏 50ml (75mm)
- 📏 60ml (90mm)
- 📏 70ml (100mm)
- 📏 75ml (105mm)
- 📏 80ml (110mm)
- 📏 90ml (115mm)
- 📏 100ml (120mm)
- 📏 125ml (145mm)
- 📏 150ml (165mm)
- ②

50MM TUBE SNAP ON OVAL

RPC_GN0014

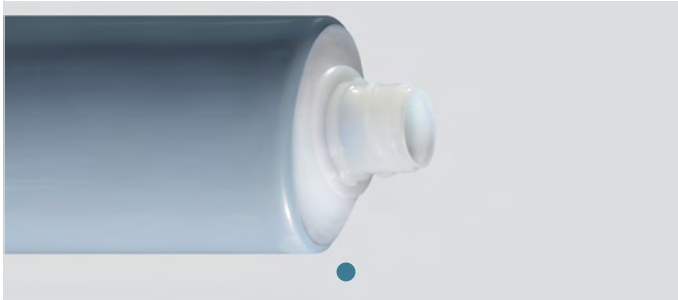

- ⌀ 22mm
- 🔧 Snap On
- 📏 Oval
- 🌀 LD/Co Ex, Smooth
- 📦 50mm Snap On
- 📏 100ml (90mm)
- 📏 125ml (105mm)
- 📏 150ml (120mm)
- 📏 175ml (135mm)
- 📏 200ml (150mm)
- 📏 225ml (165mm)
- 📏 250ml (180mm)
- ①

19MM SCREW CAP

CON_COQ118



- ⌀ 19mm
- 🔧 Screw On
- 📏 Round
- 🌀 PP, Smooth
- 📦 Plug
- ⑨
- ⑩

RELATED PRODUCTS

CLOSURES

- ① 50MM SNAP ON FLIP TOP NT OVAL
RPC_GN0033 PG 44
- ② 40MM SCREW ON FLIP TOP NT OVAL
RPC_GN0032 PG 44

TUBES

- ③ 25MM TUBE SCREW ON
RPC_GN0003 PG 41
- ④ 30MM TUBE SCREW ON
RPC_GN0004 PG 41
- ⑤ 35MM TUBE SCREW ON
RPC_GN0005 PG 41
- ⑥ 35MM TUBE SNAP ON
RPC_GN0006 PG 42
- ⑦ 40MM TUBE SNAP ON
RPC_GN0007 PG 42
- ⑧ 50MM TUBE SNAP ON
RPC_GN0009 PG 42
- ⑨ 19MM DROPPER TUBE
RPC_GN0001 PG 41
- ⑩ 19MM LIP BALM TUBE
RPC_GN0002 PG 41

25MM SCREW ON FLIP TOP NT

CON_COQ828L



- ⌀ 15mm
- 🔧 Screw
- 📏 Round
- 🌀 PP, Smooth
- 📦 Foil/Plug
- ③

25MM SCREW CAP

CON_COQ001



- ⌀ 15mm
- 🔧 Screw Cap
- 📏 Round
- 🌀 PP, Smooth
- 📦 Foil/Plug
- ③
- ④
- ⑤

30MM SCREW CAP

CON_COQ014



- ⌀ 15mm/22mm
- 🔧 Screw Cap
- 📏 Round
- 🌀 PP, Smooth
- 📦 Foil/Plug
- ③
- ④
- ⑤

35MM SCREW CAP

CON_COQ021



- ⌀ 15mm/22mm
- 🔧 Screw Cap
- 📏 Round
- 🌀 PP, Smooth
- 📦 Foil/Plug
- ③
- ④
- ⑤











35MM SNAP ON FLIP TOP TE

CON_COQ028



- ⌀ 15mm/22mm
- 🔧 Snap On
- 📏 Round
- 🌀 PP, Smooth
- 📦 Flip Top, TE
- ⑥
- ⑦
- ⑧

⌀ NECK DIAMETER 📏 NECK TYPE 📏 SHAPE 🌀 MATERIAL 📦 CLOSURE 📏 VOLUME / ○ STANDARD COLOUR OPTIONS AVAILABLE





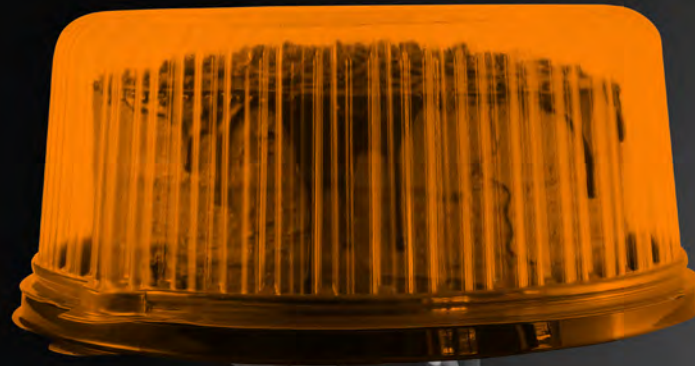





<p>35MM SNAP ON FLIP TOP NT RPC_GN0034</p>  <p>① 15mm/22mm ② Snap On ③ Round ④ PP, Smooth ⑤ Flip Top, NT</p>	<p>40MM SNAP ON FLIP TOP NT CON_COQ032</p>  <p>② 22mm ③ Snap On ④ Round ⑤ PP, Smooth ⑥ Flip Top, NT</p>	<p>40MM SNAP ON FLIP TOP TE CON_COQ035</p>  <p>② 22mm ③ Snap On ④ Round ⑤ PP, Smooth ⑥ Flip Top, TE</p>	<p>50MM SNAP ON FLIP TOP NT CON_COQ236</p>  <p>③ 22mm ④ Snap On ⑤ Round ⑥ PP, Smooth ⑦ Flip Top, NT</p>	<p>50MM SNAP ON FLIP TOP TE CON_COQ042</p>  <p>③ 22mm ④ Snap On ⑤ Round ⑥ PP, Smooth ⑦ Flip Top, TE</p>	<p>RELATED PRODUCTS TUBES</p> <ul style="list-style-type: none"> ① 35MM TUBE SNAP ON RPC_GN0006 PG 42 ② 40MM TUBE SNAP ON RPC_GN0007 PG 42 ③ 50MM TUBE SNAP ON RPC_GN0009 PG 42 ④ 50MM TUBE SCREW ON RPC_GN0008 PG 42 ⑤ 30MM TUBE SCREW ON OVAL RPC_GN0012 PG 42 ⑥ 40MM TUBE SCREW ON OVAL RPC_GN0013 PG 43 ⑦ 50MM TUBE SNAP ON OVAL RPC_GN0014 PG 43
<p>50MM SCREW CAP CON_COQ803</p>  <p>④ 22mm ⑤ Screw Cap ⑥ Round ⑦ PP, Smooth ⑧ Foil/Plug</p>	<p>30MM SCREW ON FLIP TOP NT OVAL RPC_GN0031</p>  <p>⑤ NA ⑥ Screw On ⑦ Oval ⑧ PP, Smooth ⑨ Flip Top, NT</p>	<p>40MM SCREW ON FLIP TOP NT OVAL RPC_GN0032</p>  <p>⑥ NA ⑦ Screw On ⑧ Oval ⑨ PP, Smooth ⑩ Flip Top, NT</p>	<p>50MM SNAP ON FLIP TOP NT OVAL RPC_GN0033</p>  <p>⑦ NA ⑧ Snap On ⑨ Oval ⑩ PP, Smooth ⑪ Flip Top, NT</p>		

① NECK DIAMETER ② NECK TYPE ③ SHAPE ④ MATERIAL ⑤ CLOSURE ⑥ VOLUME / ⑦ STANDARD COLOUR OPTIONS AVAILABLE



SECTION 7 //











CUPS & TRAYS

<p>500ML BEER CUP MAR_A000.0500.B4G.C6ZZ.0</p>  <p>○</p> <p> ⊗ NA ⌂ NA ⬡ Round ⊞ PP, Smooth ⌂ NA </p>	<p>340ML BEER CUP MAR_A000.0340.B4F.C6ZZ.0</p>  <p>○</p> <p> ⊗ NA ⌂ NA ⬡ Round ⊞ PP, Smooth ⌂ NA </p>	<p>500ML DRINKING CUP PFM_C463.12.ZZ.XXX1</p>  <p>○</p> <p> ⊗ 95mm ⌂ NA ⬡ Round ⊞ PP, Smooth ⌂ NA </p> <p>⑧ ⑨ ⑩</p>	<p>350ML DRINKING CUP PFM_C450.12.ZZ.XXX1</p>  <p>○</p> <p> ⊗ 95mm ⌂ 110.5mm ⬡ Round ⊞ PP, Smooth ⌂ NA </p> <p>⑧ ⑨ ⑩</p>	<p>RECTANGULAR TRAY - SHALLOW THE_FABL0038F</p>  <p>●</p> <p> ⊞ L 196 x W 147 x H 38 ⊞ PET ⌂ 1 </p> <p>① ⑫</p>	<p>RELATED PRODUCTS CUPS & TRAYS</p> <p>① LID THE_FACLS0312 PG 48</p> <p>② DOME FACLB0369 PG 47</p> <p>③ DOME B0316 PG 47</p> <p>④ DOME THE_FACLB0315 PG 47</p> <p>⑤ DOME THE_FACLBKK3 PG 47</p> <p>⑥ DOME B0478 PG 47</p> <p>⑦ DOME B0616 PG 47</p> <p>⑧ DOME LID L025 PG 48</p> <p>⑨ LID 250G RAISED PP CLEAR L276 PG 49</p> <p>⑩ 95MM FLAT CLEAR LID L275 PG 49</p> <p>⑪ DOME B0329 PG 49</p> <p>⑫ LID TO FIT RECTANGULAR TRAY FACLS0312 PG 57</p> <p>⑬ TART DOME FACLBK96 PG 58</p>
<p>CAKE BASE THE_FABLA0035</p>  <p>●</p> <p> ⊞ L 215 x W 215 x H 16 ⊞ PET ⌂ 1 </p> <p>② ⑬</p>	<p>ROUND CAKE BASE B0317</p>  <p>●</p> <p> ⊞ L 270 x W 270 x H 15 ⊞ PET ⌂ 1 </p> <p>③ ④ ⑪</p>	<p>ROUND CAKE BASE THE_FABLBKK1</p>  <p>●</p> <p> ⊞ L 235 x W 235 x H 12 ⊞ PET ⌂ 1 </p> <p>⑤</p>	<p>CAKE BASE B0454</p>  <p>●</p> <p> ⊞ L 259 x W 259 x H 25 ⊞ PET ⌂ 1 </p> <p>⑥</p>	<p>CAKE BASE B0617</p>  <p>●</p> <p> ⊞ L 255 x W 255 x H 16 ⊞ PET ⌂ 1 </p> <p>⑦</p>	







⊗ NECK DIAMETER ⌂ NECK TYPE ⬡ SHAPE ⊞ MATERIAL ⌂ CLOSURE ⌂ COMPONENTS ⊞ DIMENSIONS (MM) / ○ STANDARD COLOUR OPTIONS AVAILABLE

<p>CAKE DOME 120 THE_FACLB0315</p>  <p>⊠ L 270 x W 270 x H 120 ① 🌀 PET 📦 1</p>	<p>CAKE DOME 120 B0316</p>  <p>⊠ L 270 x W 270 x H 95 ① 🌀 PET 📦 1</p>	<p>ROUND TART DOME RIBBED - LOW THE_FACLBK107R</p>  <p>⊠ L 270 x W 270 x H 52 ⑨ 🌀 PET 📦 1</p>	<p>TART DOME THE_FABLBKK3</p>  <p>⊠ L 235 x W 235 x H 55 ② 🌀 PET 📦 1</p>	<p>10 SIDED CAKE DOME FACLB0369</p>  <p>⊠ L 213 x W 213 x H 88 ③ 🌀 PET 📦 1</p>	<p>RELATED PRODUCTS CUPS & TRAYS</p> <p>① BASE B0317 PG 46</p> <p>② BASE THE_FABLBKK1 PG 46</p> <p>③ BASE FABLA0035 PG 46</p> <p>④ BASE B0454 PG 46</p> <p>⑤ BASE B0617 PG 46</p> <p>⑥ LID THE_FACLS0312 PG 48</p> <p>⑦ HAMBURGER BASE THE_LBLP0454 PG 48</p> <p>⑧ LID TO FIT RECTANGULAR TRAY FACLS0312 PG 57</p> <p>⑨ CAKE BASE FABLBK104R PG 58</p>
<p>CAKE DOME B0478</p>  <p>⊠ L 265 x W 265 x H 95 ④ 🌀 PET 📦 1</p>	<p>CAKE DOME B0616</p>  <p>⊠ L 255 x W 255 x H 110 ⑤ 🌀 PET 📦 1</p>	<p>HAMBURGER DOME THE_FACLB158N</p>  <p>⊠ L 150 x W 145 x H 49 ⑦ 🌀 PET 📦 1</p>	<p>RECTANGULAR CAKE DOME THE_FACLBK73D</p>  <p>⊠ L 243 x W 160 x H 50 🌀 PET 📦 1</p>	<p>RECTANGULAR TRAY - SHALLOW THE_FACL0038F</p>  <p>⊠ L 196 x W 147 x H 38 ⑥ 🌀 PET 📦 1</p>	











⊙ NECK DIAMETER 📏 NECK TYPE 📐 SHAPE 🌀 MATERIAL 📦 CLOSURE 📦 COMPONENTS ⊠ DIMENSIONS (MM) / ○ STANDARD COLOUR OPTIONS AVAILABLE

<p>SALAD FOLDOVER 500ML THE_FACLP0753</p>  <p>○</p> <p>☒ L 150 x W 150 x H 65 ☄ PET 📦 1</p>	<p>LID FOR RECTANGULAR TRAYS THE_FACLS0312</p>  <p>○</p> <p>☒ L 200 x W 150 x H 15 ☄ PET 📦 1</p> <p>① ② ⑬</p>	<p>LONG BREAD ROLL BASE THE_LBLP0453</p>  <p>●</p> <p>☒ L 214 x W 105 x H 23 ☄ PP 📦 1</p> <p>⑥</p>	<p>HAMBURGER BASE THE_LBLP0454</p>  <p>●</p> <p>☒ L 147 x W 126 x H 23 ☄ PP 📦 1</p> <p>③</p>	<p>OVAL MEAL TRAY - 3 CAVITY THE_LBLP0465</p>  <p>●</p> <p>☒ L 230 x W 180 x H 33 ☄ PP 📦 1</p>	<p>RELATED PRODUCTS CUPS & TRAYS</p> <ul style="list-style-type: none"> ① TRAY THE_FABL0038F PG 46 ② TRAY THE_FACL0038F PG 47 ③ DOME THE_FACLP0505 PG 48 ④ BASE THE_LBLP0454 PG 48 ⑤ BASE THE_LBLP0453 PG 48 ⑥ LONG BREAD ROLL DOME THE_FACLP0506 PG 48 ⑦ 500ML DRINKING CUP C463 PG 46 ⑧ 150ML CUP C428 PG 49 ⑨ 150ML MOUSSE CUP C415 PG 49 ⑩ 50ML VENETIAN C425 PG 49 ⑪ 100ML CLEAR TUB C426 PG 49 ⑫ 150ML WHITE CUP C428 PG 49 ⑬ CUP 500ML C468 PG 53 ⑭ TRAY P0431 PG 50 ⑮ TRAY P0432 PG 50 ⑯ TRAY FACL00100 PG 50 ⑰ LID FACL00477 PG 50 ⑱ CUP 55ML DEEP PP CLEAR C438.12.ZZ.XXX1 PG 55 ⑲ CUP 76ML DEEP PP CLEAR C447.12.ZZ.XXX1 PG 56
<p>LASAGNE TRAY LID THE_FACLP0442</p>  <p>○</p> <p>☒ L 175 x W 132 x H 9 ☄ PET 📦 1</p> <p>⑭ ⑮</p>	<p>HAMBURGER DOME THE_FACLP0505</p>  <p>○</p> <p>☒ L 150 x W 130 x H 50 ☄ PET 📦 1</p> <p>④</p>	<p>LONG BREAD ROLL DOME THE_FACLP0506</p>  <p>○</p> <p>☒ L 216 x W 110 x H 38 ☄ PET 📦 1</p> <p>⑤</p>	<p>SANDWICH WEDGE FOLDOVER ES004 THE_FACLP0434</p>  <p>○</p> <p>☒ L 380 x W 96 x H 85 ☄ PET 📦 1</p>	<p>98MM CLEAR POLYPROP DOME LID L025.12.ZZ.XXX1</p>  <p>○</p> <p>☒ DIAM 96 x H 32.5 ☄ PP 📦 1</p> <p>⑰ ⑱ ⑲ ⑳ ㉑ ㉒ ㉓</p>	











☉ NECK DIAMETER 📏 NECK TYPE 📐 SHAPE ☄ MATERIAL 📦 CLOSURE 📦 COMPONENTS ☒ DIMENSIONS (MM) / ○ STANDARD COLOUR OPTIONS AVAILABLE

<p>LID SMALL 74.6MM CLEAR PP L101.12.ZZ.XXX1</p>  <p>DIAM 74 x H 10.5 PP 1</p> <p>⑨ ⑩</p>	<p>LID 250G RAISED PP CLEAR L276.12.ZZ.XXX1</p>  <p>DIAM 98 x H 12.5 PP 1</p> <p>② ③ ④ ⑤ ⑥ ⑬ ⑭</p>	<p>95MM FLAT CLEAR POLYPROP LID L275.12.ZZ.XXX3</p>  <p>DIAM 98 x H 7.3 PP 1</p> <p>② ③ ④ ⑤ ⑥ ⑬ ⑭</p>	<p>150ML CLEAR POLYPROP CUP C428.12.ZZ.XXX3</p>  <p>DIAM 95 x H 43.5 PP 1</p> <p>① ⑦ ⑧</p>	<p>150ML WHITE POLYPROP CUP C428.08.ZZ.XXX3</p>  <p>DIAM 95 x H 43.5 PP 1</p> <p>① ⑦ ⑧</p>	<p>RELATED PRODUCTS CUPS & TRAYS</p> <ul style="list-style-type: none"> ① 98MM DOME LID L025 PG 48 ② 500ML DRINKING CUP C463 PG 46 ③ 350ML DRINKING CUP C450 PG 46 ④ 150ML CLEAR VENETIAN C425 PG 49 ⑤ 100ML SMALL CLEAR TUB C426 PG 49 ⑥ 150ML WHITE CUP C428 PG 49 ⑦ 250G LID L276 PG 49 ⑧ 95MM FLAT LID L275 PG 49 ⑨ 250G WHITE CUP C257 PG 51 ⑩ 100G CUP C218 PG 52 ⑪ BASE B0317 PG 46 ⑫ BASE FABLP2157 ⑬ CUP 55ML DEEP PP CLEAR C438.12.ZZ.XXX1 PG 55 ⑭ CUP 76ML DEEP PP CLEAR C447.12.ZZ.XXX1 PG 56
<p>150ML CLEAR POLYPROP VENETIAN C425.12.ZZ.XXX1</p>  <p>DIAM 95 x H 52.5 PP 1</p> <p>① ⑦ ⑧</p>	<p>100ML SMALL CLEAR TUB C426.12.ZZ.XXX2</p>  <p>DIAM 95 x H 32.5 PP 1</p> <p>① ⑦ ⑧</p>	<p>150ML CLEAR POLYPROP MOUSSE CUP C415.12.ZZ.XXX1</p>  <p>DIAM 95 x H 52.5 PP 1</p> <p>① ⑦ ⑧</p>	<p>TART DOME 50 FACLB0329</p>  <p>L 270 x W 270 x H 13 PET 1</p> <p>⑪</p>	<p>TART DOME FACLP218R</p>  <p>L 250 x W 250 x H 75 PET 1</p> <p>⑫</p>	









⊙ NECK DIAMETER 📏 NECK TYPE 📐 SHAPE 🧵 MATERIAL 📦 CLOSURE 📦 COMPONENTS 📏 DIMENSIONS (MM) / ○ STANDARD COLOUR OPTIONS AVAILABLE

<p>ROUND CAKE BASE FABLP215Z</p>  <p>☒ L 263 x W 263 x H 25 ① ☄ PET 📦 1</p>	<p>LASAGNE TRAY - DEEP LBLP0431</p>  <p>☒ L 175 x W 130 x H 47 ③ ☄ PP 📦 1</p>	<p>LASAGNE TRAY - SHALLOW LBLP0432</p>  <p>☒ L 175 x W 130 x H 33 ③ ☄ PP 📦 1</p>	<p>TRAY RECTANGULAR - SHALLOW FABLP0743</p>  <p>☒ L 230 x W 147 x H 38 ② ☄ PET 📦 1</p>	<p>TRAY RECTANGULAR - MEDIUM FACL0070</p>  <p>☒ L 196 x W 147 x H 67 ⑥ ☄ PET 📦 1</p>	<p>RELATED PRODUCTS CUPS & TRAYS</p> <ul style="list-style-type: none"> ① DOME FACL P218R PG 49 ② LID FACL P0742 PG 53 ③ LID FACL P0442 PG 50 ④ LID THE_FACL S0312 PG 48 ⑤ TRAY LBL P0465 PG 48 ⑥ TRAY INSERT FOR RECTANGULAR TRAY FACL P0688 PG 60
<p>RECTANGULAR TRAY - DEEP FACL00100</p>  <p>☒ L 196 x W 147 x H 95 ④ ☄ PET ⑥ 📦 1</p>	<p>FLAT LID TO FIT OVAL MEAT TRAY FACL P0477</p>  <p>☒ L 240 x W 187 x H 12 ⑤ ☄ PET 📦 1</p>	<p>HIGH LID TO FIT OVAL MEAT TRAY FACL P0821</p>  <p>☒ L 240 x W 187 x H 35 ⑤ ☄ PET 📦 1</p>	<p>TRAY RECTANGULAR - SHALLOW FACL P0743</p>  <p>☒ L 230 x W 147 x H 38 ☄ PET 📦 1</p>	<p>CLAMPACK MUFFIN - 4 CAVITY FACL BKK8</p>  <p>☒ L 187 x W 175 x H 75 ☄ PET 📦 1 Foldover</p>	











☉ NECK DIAMETER ☒ NECK TYPE ☐ SHAPE ☄ MATERIAL ☒ CLOSURE 📦 COMPONENTS ☒ DIMENSIONS (MM) / ○ STANDARD COLOUR OPTIONS AVAILABLE

<p>CLAMPACK MUFFIN - 6 CAVITY FACLBKK9</p>  <p>○</p> <p>☒ L 375 x W 160 x H 73 ☄ PET 📦 1 Foldover</p>	<p>250G POLYPROP CLEAR C257.12.ZZ.XXX3</p>  <p>○</p> <p>☒ DIAM 70.7 x H 114 ☄ PP 📦 1</p> <p>① ②</p>	<p>200ML VENDING POLYPROP CLEAR C266.12.ZZ.XXX2</p>  <p>○</p> <p>☒ DIAM 70.7 x H 95 ☄ PP 📦 1</p> <p>① ②</p>	<p>CUP 250G POLYPROP WHITE C257.08.ZZ.XXX3</p>  <p>●</p> <p>☒ DIAM 70.7 x H 114 ☄ PP 📦 1</p> <p>① ②</p>	<p>FOLDOVER P395</p>  <p>○</p> <p>☒ L 271 x W 153 x H 61 ☄ PET 📦 1 Foldover</p>	<p>RELATED PRODUCTS CUPS & TRAYS</p> <p>① LID SMALL 74.6MM L101 PG 49</p> <p>② LID 74.65MM DOME L015 PG 52</p>
<p>FOLDOVER P397</p>  <p>○</p> <p>☒ L 334 x W 190 x H 57 ☄ PET 📦 1 Foldover</p>	<p>FOLDOVER P398</p>  <p>○</p> <p>☒ L 334 x W 190 x H 70 ☄ PET 📦 1 Foldover</p>	<p>HOT FOOD 350ML FOLDOVER LCLP0863</p>  <p>○</p> <p>☒ L 290 x W 40 x H 40 ☄ PP 📦 1 Foldover</p>	<p>HOT FOOD 500ML FOLDOVER LCLP0864</p>  <p>○</p> <p>☒ L 293 x W 145 x H 56 ☄ PP 📦 1 Foldover</p>	<p>HOT FOOD 800ML FOLDOVER LCLP0865</p>  <p>○</p> <p>☒ L 334 x W 164 x H 60 ☄ PP 📦 1 Foldover</p>	











🕒 NECK DIAMETER 📏 NECK TYPE 📐 SHAPE ☄ MATERIAL 📦 CLOSURE 📦 COMPONENTS ☒ DIMENSIONS (MM) / ○ STANDARD COLOUR OPTIONS AVAILABLE

<p>CUP 114ML / 250ML PP CLEAR SLVD C510.12.ZZ.XXX1</p>  <p>DIAM 114 x H 60 PP 1</p> <p>⑨</p>	<p>CUP 114ML / 350ML PP CLEAR SLVD C516.12.ZZ.XXX3</p>  <p>DIAM 114 x H 56.5 PP 1</p> <p>⑨</p>	<p>CUP 40ML DEEP BOWL PP CLEAR C712.12.ZZ.XXX2</p>  <p>DIAM 156 x H 39.5 PP 1</p> <p>⑧ ⑩ ⑪</p>	<p>LID TO FIT 114MM DM CLEAR PP L601.12.ZZ.XXX2</p>  <p>DIAM 117 x H 9 PP 1</p> <p>⑧ ⑩ ⑪</p>	<p>LID 128.5MM RAISED CLEAR PP L384.12.ZZ.XXX1</p>  <p>DIAM 129 x H 16 PP 1</p> <p>⑫</p>	<p>RELATED PRODUCTS CUPS & TRAYS</p> <ul style="list-style-type: none"> ① SMALL LID 74.6MM L101 PG 49 ② 250G POLYPROP CLEAR C257 PG 51 ③ 200ML VENDING CLEAR C266 PG 51 ④ CUP 150ML CLEAR C238 PG 52 ⑤ CUP 175ML CLEAR C246 PG 52 ⑥ CUP 100GR WHITE C218 PG 52 ⑦ LID 74.65MM DOME L015 PG 52 ⑧ CUP 114ML / 250ML CLEAR C510 PG 52 ⑨ LID TO FIT 114MM CLEAR L601 PG 52 ⑩ CUP 114ML / 350ML CLEAR C516 PG 52 ⑪ CUP 114ML/500ML PP CLEAR C521.12.ZZ.XXX3 PG 55 ⑫ CUP 80ML DEEP PP CLEAR C673.12.ZZ.XXX1 PG 55
<p>CUP 100GR CLEAR PP C218.12.ZZ.XXX1</p>  <p>DIAM 70.7 x H 46 PP 1</p> <p>① ⑦</p>	<p>LID 74.65MM DOME CLEAR PP L015.12.ZZ.XXX1</p>  <p>DIAM 74 x H 21.5 PP 1</p> <p>② ③ ④ ⑤ ⑥</p>	<p>CUP 150ML PP CLEAR C238.12.ZZ.XXX1</p>  <p>DIAM 70.7 x H 73.5 PP 1</p> <p>① ⑦</p>	<p>CUP 175ML PP CLEAR C246.12.ZZ.XXX1</p>  <p>DIAM 70.7 x H 87 PP 1</p> <p>① ⑦</p>	<p>CUP 100GR WHITE PP C218.08.ZZ.XXX1</p>  <p>DIAM 70.7 x H 46 PP 1</p> <p>① ⑦</p>	











⊗ NECK DIAMETER 𠂆 NECK TYPE 𠂇 SHAPE 𠂈 MATERIAL 𠂉 CLOSURE 𠂊 COMPONENTS 𠂋 DIMENSIONS (MM) / ○ STANDARD COLOUR OPTIONS AVAILABLE

<p>CUP 150ML PP WHITE C238.08.ZZ.XXX1</p>  <p>DIAM 70.7 x H 73.5 PP 1</p> <p>② ③</p>	<p>CUP 500ML DRINK PP CLEAR C468.12.ZZ.XXX1</p>  <p>DIAM 95 x H 127.5 PP 1</p> <p>① ④ ⑤</p>	<p>CHOCOLATE FUDGE TRAY - 5 CAVITY FABLB0491</p>  <p>L 257 x W 83 x H 22 PET 1</p>	<p>LID TO FIT RECTANGULAR TRAY FACLP0742</p>  <p>L 230 x W 147 x H 38 PET 1</p> <p>⑥</p>	<p>MUFFIN FOLDOVER WITH DOME - 6 CAVITY FACLB0592</p>  <p>L 241 x W 230 x H 52 PET 1</p>	<p>RELATED PRODUCTS CUPS & TRAYS</p> <ul style="list-style-type: none"> ① 98MM LID DOME L025 PG 48 ② LID SMALL 74.6MM L101 PG 49 ③ LID 74.65MM DOME L015 PG 52 ④ 250G LID CLEAR RAISED L276 PG 49 ⑤ 95MM FLAT CLEAR L275 PG 49 ⑥ TRAY RECTANGLE FABLP0743 PG 50
<p>MINI CUP CAKE - 12 CAVITY FACLB193N</p>  <p>L 230 x W 170 x H 50 PET 1</p>	<p>MUFFIN TRAY - 6 CAVITY FACLB190T</p>  <p>L 225 x W 150 x H 25 PET 1</p>	<p>RECTANGULAR TRAY - SHALLOW - HOT FILL LCL0038F</p>  <p>L 196 x W 147 x H 38 PP 1</p>	<p>SALAD FOLDOVER 350ML FACLP0752</p>  <p>L 150 x W 150 x H 40 PET 1</p>	<p>FOLDOVER TART FACLB0704</p>  <p>L 233 x W 233 x H 30 PET 1</p>	







⊗ NECK DIAMETER 𐀀 NECK TYPE 𐀁 SHAPE 𐀂 MATERIAL 𐀃 CLOSURE 𐀄 COMPONENTS 𐀅 DIMENSIONS (MM) / ○ STANDARD COLOUR OPTIONS AVAILABLE

<p>ROUND CAKE BASE FABL0317</p>  <p>☒ L 270 x W 270 x H 15 ☒ PET ☒ 1</p> <p>① ② ③</p>	<p>CAKE BASE FABLA0035</p>  <p>☒ L 215 x W 215 x H 15 ☒ PET ☒ 1</p> <p>④</p>	<p>RECTANGULAR TRAY - LARGE FABLM0180</p>  <p>☒ L 265 x W 180 x H 27 ☒ PET ☒ 1</p> <p>⑩</p>	<p>RECTANGULAR TRAY 2 CAVITY FABLP0474</p>  <p>☒ L 265 x W 180 x H 27 ☒ PET ☒ 1</p> <p>⑩</p>	<p>HAMBURGER BASE FACLP0454</p>  <p>☒ L 147 x W 126 x H 23 ☒ Polypropylene ☒ 1</p> <p>⑤</p>	<p>RELATED PRODUCTS CUPS & TRAYS</p> <p>① DOME B0316 PG 47</p> <p>② DOME THE_FACLB0315 PG 47</p> <p>③ DOME B0329 PG 49</p> <p>④ DOME B0369N PG 47</p> <p>⑤ DOME THE_FACLP0505 PG 48</p> <p>⑥ LID THE_FACLS0312 PG 48</p> <p>⑦ SWISS ROLL LID - DEEP FACLBKK6 PG 55</p> <p>⑧ SWISS ROLL BASE FACLBKK4 PG 55</p> <p>⑨ LID SMALL 74.6MM L101 PG 49</p> <p>⑩ LID FACLB0158 PG 57</p>
<p>RECTANGULAR TRAY - MEDIUM FACL00070</p>  <p>☒ L 196 x W 147 x H 90 ☒ PET ☒ 1</p> <p>⑥</p>	<p>SWISS ROLL BASE FACLBKK4</p>  <p>☒ L 265 x W 265 x H 20 ☒ PET ☒ 1</p> <p>⑦</p>	<p>SWISS ROLL LID - DEEP FACLBKK6</p>  <p>☒ L 255 x W 140 x H 80 ☒ PET ☒ 1</p> <p>⑧</p>	<p>CUP 125ML POLYPROP WHITE C220.08.ZZ.XXX1</p>  <p>☒ DIAM 70.7 x H 59.5 ☒ PP ☒ 1</p> <p>⑨</p>	<p>CUP 125ML PP CLEAR C220.12.ZZ.XXX1</p>  <p>☒ DIAM 70.7 x H 59.5 ☒ PP ☒ 1</p> <p>⑨</p>	











☒ NECK DIAMETER ☒ NECK TYPE ☒ SHAPE ☒ MATERIAL ☒ CLOSURE ☒ COMPONENTS ☒ DIMENSIONS (MM) / ○ STANDARD COLOUR OPTIONS AVAILABLE

<p>CUP 125G PP CLEAR C228.12.ZZ.XXX1</p>  <p>DIAM 70.7 x H 78 ① PP 1</p>	<p>250ML WHITE POLYPROP CUP C429.08.ZZ.XXX3</p>  <p>DIAM 95 x H 63 ② PP ③ 1 ④</p>	<p>55MM DEEP CLEAR PP C432.12.ZZ.XXX1</p>  <p>DIAM 95 x H 52.5 ② PP ③ 1 ④</p>	<p>CUP 1KG PP CLEAR C611.12.ZZ.XXX1</p>  <p>DIAM 125.5 x H 131 ⑤ PP 1</p>	<p>CUP 350ML POLYPROP CLEAR C652.12.ZZ.XXX1</p>  <p>DIAM 125.5 x H 47.5 ⑤ PP 1</p>	<p>RELATED PRODUCTS CUPS & TRAYS</p> <p>① LID SMALL 74.6MM L101 PG 49</p> <p>② DOME LID L025 PG 48</p> <p>③ 95MM FLAT CLEAR LID L275 PG 49</p> <p>④ LID 250G RAISED PP CLEAR L276 PG 49</p> <p>⑤ LID 128.5MM RAISED CLEAR PP L384.12.ZZ.XXX1 PG 52</p> <p>⑥ LID TO FIT 114MM CLEAR L601.12.ZZ.XXX2 PG 52</p>
<p>CUP 500ML POLYPROP CLEAR C663.12.ZZ.XXX1</p>  <p>DIAM 125.5 x H 65.5 ⑤ PP 1</p>	<p>CUP 720ML PP CLEAR WFLNG DB LINE C668.12.ZZ.XXX1</p>  <p>DIAM 125.5 x H 97.5 ⑤ PP 1</p>	<p>CUP 55ML DEEP PP CLEAR C438.12.ZZ.XXX1</p>  <p>DIAM 95 x H 54.5 ② PP ③ 1 ④</p>	<p>CUP 80ML DEEP PP CLEAR C673.12.ZZ.XXX1</p>  <p>DIAM 125.5 x H 79.5 ⑤ PP 1</p>	<p>CUP 114ML/500ML PP CLEAR SLVD C521.12.ZZ.XXX3</p>  <p>DIAM 114 x H 81 ⑥ PP 1</p>	







⊗ NECK DIAMETER 𠄎 NECK TYPE 𠄎 SHAPE 𠄎 MATERIAL 𠄎 CLOSURE 𠄎 COMPONENTS 𠄎 DIMENSIONS (MM) / ○ STANDARD COLOUR OPTIONS AVAILABLE

<p>CUP 76ML DEEP PP CLEAR C447.12.ZZ.XXX1</p>  <p>○</p> <p>☒ DIAM 95 x H 76.5 ① ☄ PP ② 📦 1 ③</p>	<p>SWISSROLL FOLDOVER FACLB196T</p>  <p>○</p> <p>☒ L 180 x B 275 x H 100 ☄ PET 📦 1</p>	<p>MINCE PIE FOLDOVER FACLP0195</p>  <p>○</p> <p>☒ L 332 x B 243 x H 34 ☄ PET 📦 1</p>	<p>CHOCOLATE FUDGE TRAY - 5 CAVITY FACLB0491</p>  <p>○</p> <p>☒ L 257 x B 83 x H 22 ☄ PET 📦 1</p>	<p>MINI CUP CAKE WITH RAISED POST - 9 CAVITY FACLB0611</p>  <p>○</p> <p>☒ L 177 x B 174 x H 60 ☄ PET 📦 1</p>	<p>RELATED PRODUCTS CUPS & TRAYS</p> <p>① DOME LID L025 PG 48</p> <p>② 95MM FLAT CLEAR LID L275 PG 49</p> <p>③ LID 250G RAISED PP CLEAR L276 PG 49</p> <p>④ RECTANGULAR CAKE BASE FABLB0388N PG 57</p>
<p>RECTANGULAR DOME - HIGH FACLBK79B</p>  <p>○</p> <p>☒ L 296 x B 243 x H 100 ④ ☄ PET 📦 1</p>	<p>RECTANGULAR DOME - LOW FACLBK79D</p>  <p>○</p> <p>☒ L 296 x B 243 x H 50 ④ ☄ PET 📦 1</p>	<p>SQUARE DOME - MEDIUM FACLBK105N</p>  <p>○</p> <p>☒ L 280 x B 280 x H 90 ☄ PET 📦 1</p>	<p>SQUARE DOME - SMALL FACLBK79</p>  <p>○</p> <p>☒ L 235 x B 235 x H 60 ☄ PET 📦 1</p>	<p>RECTANGULAR DOME RIBBED - MEDIUM FACLBK79CR</p>  <p>○</p> <p>☒ L 283 x B 226 x H 87 ④ ☄ PET 📦 1</p>	

📏 NECK DIAMETER 📏 NECK TYPE 📏 SHAPE ☄ MATERIAL 📏 CLOSURE 📦 COMPONENTS ☒ DIMENSIONS (MM) / ○ STANDARD COLOUR OPTIONS AVAILABLE

<p>RECTANGULAR DOME FACLBK75</p>  <p>○</p> <p>☒ L 280 x B 150 x H 95 ① ☒ PET ☒ 1</p>	<p>LID FACLB0158</p>  <p>○</p> <p>☒ L 270 x B 185 x H 20 ② ☒ PET ③ ☒ 1 ④</p>	<p>LID TO FIT RECTANGULAR TRAY FACLS0312</p>  <p>○</p> <p>☒ L 200 x B 150 x H 15 ⑤ ☒ PET ⑥ ☒ 1 ⑦ ⑮</p>	<p>RECTANGULAR TRAY - LARGE FACLM0180</p>  <p>○</p> <p>☒ L 265 x B 180 x H 27 ⑧ ☒ PET ☒ 1</p>	<p>RECTANGULAR TRAY - DEEP - LARGE FABL0380</p>  <p>●</p> <p>☒ L 365 x B 180 x H 47 ⑧ ☒ PET ☒ 1</p>	<p>RELATED PRODUCTS CUPS & TRAYS</p> <ul style="list-style-type: none"> ① RECTANGULAR CAKE BASE FACLB0358 PG 57 ② RECTANGULAR TRAY LARGE FACLM0180 PG 54 ③ RECTANGULAR TRAY 2 CAVITY FABLP0474 PG 54 ④ RECTANGULAR TRAY DEEP LARGE FABL0380 PG 57 ⑤ RECTANGULAR TRAY SHALLOW THE_FACLO038F PG 47 ⑥ RECTANGULAR TRAY SHALLOW THE_FABLO038F PG 46 ⑦ RECTANGULAR TRAY MEDIUM FACLO070 PG 50 ⑧ LID FACLB0158 PG 57 ⑨ RECTANGULAR DOME HIGH FACLBK79B PG 56 ⑩ RECTANGULAR DOME LOW FACLBK79D PG 56 ⑪ SCREW-LOC CAKE DOME 95MM FACLB0562 PG 58 ⑫ SCREW-LOC CAKE DOME 125MM FACLB0561 PG 58 ⑬ RECTANGULAR DOME RIBBED - MEDIUM FACLBK79CR PG 56 ⑭ RECTANGULAR DOME FACLBK75 PG 57 ⑮ TRAY INSERT FOR RECTANGULAR TRAY FACLP0688 PG 60
<p>RECTANGULAR CAKE BASE FABL0358</p>  <p>●</p> <p>☒ L 243 x B 160 x H 50 ⑭ ☒ PET ☒ 1</p>	<p>RECTANGULAR CAKE BASE FABL0388N</p>  <p>●</p> <p>☒ L 300 x B 244 x H 15 ⑨ ☒ PET ⑩ ☒ 1 ⑬</p>	<p>? B108N</p>  <p>●</p> <p>☒ PET ☒ 1</p>	<p>CAKE BASE SCREW-LOC FABLA0035SL</p>  <p>●</p> <p>☒ L 215 x B 215 x H 15 ☒ PET ☒ 1</p>	<p>CAKE BASE SCREW-LOC FABL0471N</p>  <p>●</p> <p>☒ L 265 x B 265 x H 25 ⑪ ☒ PET ⑫ ☒ 1</p>	











○ NECK DIAMETER ☒ NECK TYPE ☒ SHAPE ☒ MATERIAL ☒ CLOSURE ☒ COMPONENTS ☒ DIMENSIONS (MM) / ○ STANDARD COLOUR OPTIONS AVAILABLE

<p>CAKE BASE FAPLAK104R</p>  <p> <input checked="" type="checkbox"/> L 270 x B 270 x H 20 <input checked="" type="checkbox"/> PET <input type="checkbox"/> 1 </p> <p>① ② ③ ④</p>	<p>ROUND CAKE DOME FAPLAK214N</p>  <p> <input checked="" type="checkbox"/> L 270 x B 270 x H 105 <input checked="" type="checkbox"/> PET <input type="checkbox"/> 1 </p> <p>⑤</p>	<p>ROUND TART DOME RIBBED - MEDIUM FAPLAK106R</p>  <p> <input checked="" type="checkbox"/> L 270 x B 270 x H 85 <input checked="" type="checkbox"/> PET <input type="checkbox"/> 1 </p> <p>⑥</p>	<p>ROUND TART DOME RIBBED - MEDIUM FAPLAK108R</p>  <p> <input checked="" type="checkbox"/> L 270 x B 270 x H 52 <input checked="" type="checkbox"/> PET <input type="checkbox"/> 1 </p> <p>⑥</p>	<p>ROUND CAKE DOME RIBBED - HIGH FAPLAK101R</p>  <p> <input checked="" type="checkbox"/> L 270 x B 270 x H 108 <input checked="" type="checkbox"/> PET <input type="checkbox"/> 1 </p> <p>⑥</p>	<p>RELATED PRODUCTS CUPS & TRAYS</p> <p>① ROUND CAKE DOME RIBBED - HIGH FAPLAK101R PG 58</p> <p>② ROUND TART DOME RIBBED - MEDIUM FAPLAK106R PG 58</p> <p>③ ROUND TART DOME RIBBED - LOW THE_FAPLAK107R PG 47</p> <p>④ ROUND TART DOME RIBBED - MEDIUM FAPLAK108R PG 58</p> <p>⑤ ROUND CAKE BASE B0317 PG 46</p> <p>⑥ CAKE BASE FAPLAK104R PG 58</p> <p>⑦ CAKE BASE SCREW-LOC FAPLB0471N PG 57</p> <p>⑧ ROUND CAKE BASE THE_FAPLBKK1 PG 46</p> <p>⑨ CAKE BASE THE_FAPLA0035 PG46</p>
<p>SCREW-LOC CAKE DOME 95MM FAPLB0562</p>  <p> <input checked="" type="checkbox"/> L 265 x B 265 x H 105 <input checked="" type="checkbox"/> PET <input type="checkbox"/> 1 </p> <p>⑦</p>	<p>SCREW-LOC CAKE DOME 125MM FAPLB0561</p>  <p> <input checked="" type="checkbox"/> L 265 x B 265 x H 125 <input checked="" type="checkbox"/> PET <input type="checkbox"/> 1 </p> <p>⑦</p>	<p>CAKE DOME RIBBED FAPLBKK2</p>  <p> <input checked="" type="checkbox"/> L 235 x B 235 x H 100 <input checked="" type="checkbox"/> PET <input type="checkbox"/> 1 </p> <p>⑧</p>	<p>TART DOME FAPLAK95</p>  <p> <input checked="" type="checkbox"/> L 220 x B 220 x H 40 <input checked="" type="checkbox"/> PET <input type="checkbox"/> 1 </p> <p>⑧</p>	<p>TART DOME FAPLAK96</p>  <p> <input checked="" type="checkbox"/> L 215 x B 215 x H 60 <input checked="" type="checkbox"/> PET <input type="checkbox"/> 1 </p> <p>⑨</p>	

NECK DIAMETER
 NECK TYPE
 SHAPE
 MATERIAL
 CLOSURE
 COMPONENTS
 DIMENSIONS (MM) / STANDARD COLOUR OPTIONS AVAILABLE

<p>FOLDOVER TUB 70F FACLP1013</p>  <p>○</p> <p>☒ L 310 x B 203 x H 68 ☿ PET ☐ 1</p>	<p>FOLDOVER TUB 100F FACLP1009</p>  <p>○</p> <p>☒ L 310 x B 203 x H 94 ☿ PET ☐ 1</p>	<p>SALAD FOLDOVER 850ML FACLP0754</p>  <p>○</p> <p>☒ L 187 x B 187 x H 45 ☿ PET ☐ 1</p>	<p>LONG ROLL FOLDOVER FACLP0850</p>  <p>○</p> <p>☒ L 250 x B 255 x H 41 ☿ PET ☐ 1</p>	<p>STIR FRY PUNNET FACLP0625</p>  <p>○</p> <p>☒ L 225 x B 175 x H 60 ☿ PET ☐ 1</p>	<p>RELATED PRODUCTS CUPS & TRAYS</p>
<p>SANDWICH WEDGE FOLDOVER FACLP0530</p>  <p>○</p> <p>☒ L 372 x B 85 x H 85 ☿ PET ☐ 1</p>	<p>SANDWICH WEDGE FOLDOVER (ES002) FACLP0400</p>  <p>○</p> <p>☒ L 362 x B 71 x H 80 ☿ PET ☐ 1</p>	<p>SANDWICH WEDGE FOLDOVER FACLP0723</p>  <p>○</p> <p>☒ L 376 x B 94 x H 65 ☿ PET ☐ 1</p>	<p>FOLDOVER TUB 350G FACLP0970</p>  <p>○</p> <p>☒ L 260 x B 155 x H 40 ☿ PET ☐ 1</p>	<p>SALAD FOLDOVER 250ML FACLP0751</p>  <p>○</p> <p>☒ L 150 x B 150 x H 30 ☿ PET ☐ 1</p>	

○ NECK DIAMETER ☐ NECK TYPE ☐ SHAPE ☿ MATERIAL ☐ CLOSURE ☐ COMPONENTS ☒ DIMENSIONS (MM) / ○ STANDARD COLOUR OPTIONS AVAILABLE

<p>DELI TRAY 375ML FACLP0411</p>  <p>○</p> <p>☒ L 152 x B 132 x H 40 ⑤ ☄ PET 📦 1</p>	<p>DELI TRAY 500ML FACLP0395</p>  <p>○</p> <p>☒ L 152 x B 132 x H 45 ⑤ ☄ PET 📦 1</p>	<p>DELI TRAY 750ML FACLP0397</p>  <p>○</p> <p>☒ L 187 x B 163 x H 52 ① ☄ PET 📦 1</p>	<p>DELI TRAY 1000ML FACLP0398</p>  <p>○</p> <p>☒ L 187 x B 163 x H 65 ① ☄ PET 📦 1</p>	<p>DELI TRAY 1500ML FACLP0430</p>  <p>○</p> <p>☒ L 187 x B 163 x H 95 ① ☄ PET 📦 1</p>	<p>RELATED PRODUCTS CUPS & TRAYS</p> <p>① LID TO FIT DELI TRAY FACLP0399 PG 61</p> <p>② DELI TRAY 500ML FACLP0395 PG 60</p> <p>③ DELI TRAY 375ML FACLP0411 PG 60</p> <p>④ DELI TRAY 250ML FACLP0394 PG 64</p> <p>⑤ LID TO FIT DELI TRAY FACLP0396 PG 60</p> <p>⑥ TRAY RECTANGULAR - MEDIUM FACLP0070 PG 50</p> <p>⑦ RECTANGULAR TRAY - DEEP FACLP00100 PG 50</p> <p>⑧ LID TO FIT RECTANGULAR TRAY FACLP0312 PG 57</p> <p>⑨ LID TO FIT TERRINE TUB FACLP0420 PG 61</p>
<p>LID TO FIT DELI TRAY FACLP0396</p>  <p>○</p> <p>☒ L 152 x B 132 x H 11 ② ☄ PET ③ 📦 1 ④</p>	<p>DELI TRAY 250ML FABLP0394</p>  <p>●</p> <p>☒ L 152 x B 132 x H 135 ⑤ ☄ PET 📦 1</p>	<p>SQUARE TUB - SHALLOW FABLP0608</p>  <p>●</p> <p>☒ L 126 x B 126 x H 40 ☄ PET 📦 1</p>	<p>TRAY INSERT FOR RECTANGULAR TRAY FACLP0688</p>  <p>○</p> <p>☒ L 192 x B 143 x H 21 ⑥ ☄ PET ⑦ 📦 1 ⑧</p>	<p>TERRINE TUB - SHALLOW FACLP0428</p>  <p>○</p> <p>☒ L 110 x B 85 x H 30 ⑨ ☄ PET 📦 1</p>	









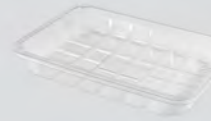

○ NECK DIAMETER 📏 NECK TYPE 📐 SHAPE ☄ MATERIAL 📦 CLOSURE 📦 COMPONENTS ☒ DIMENSIONS (MM) / ○ STANDARD COLOUR OPTIONS AVAILABLE

<p>LID TO FIT TERRINE TUB FACLP0420</p>  <p>○</p> <p>☒ L 110 x B 85 x H 8 ① ☄ PET 📦 1</p>	<p>SOLO SALAD TUB 420ML FACLP0520</p>  <p>○</p> <p>☒ L 136 x B 136 x H 40 ② ☄ PET 📦 1</p>	<p>LID FOR SOLO SALAD TUB FACLP0521</p>  <p>○</p> <p>☒ L 136 x B 136 x H 7 ③ ☄ PET 📦 1</p>	<p>ROUND THREE DIVISION SALAD TUB FACLS0396</p>  <p>○</p> <p>☒ L 185 x B 185 x H 50 ☄ PET 📦 1</p>	<p>ROUND SALAD TUB - LARGE FACLP0604</p>  <p>○</p> <p>☒ L 182 x B 182 x H 80 ☄ PET 📦 1</p>	<p>RELATED PRODUCTS CUPS & TRAYS</p> <ul style="list-style-type: none"> ① TERRINE TUB - SHALLOW FACLP0428 PG 60 ② LID FOR SOLO SALAD TUB FACLP0521 PG 61 ③ SOLO SALAD TUB 420ML FACLP0520 PG 61 ④ DELI TRAY 1500ML FACLP0430 PG 60 ⑤ DELI TRAY 750ML FACLP0397 PG 60 ⑥ DELI TRAY 1000ML FACLP0398 PG 60 ⑦ LID TO FIT ROUND SALAD TUB FACLW0231N PG 61 ⑧ ROUND SALAD TUB - SMALL FACLS0310N PG 61
<p>LID FOR SOLO SALAD TUB FACLP0519</p>  <p>○</p> <p>☒ L 180 x B 180 x H 8 ☄ PET 📦 1</p>	<p>LID TO FIT DELI TRAY FACLP0399</p>  <p>○</p> <p>☒ L 187 x B 163 x H 11 ④ ☄ PET ⑤ 📦 1 ⑥</p>	<p>ROUND SALAD TUB - SMALL FACLS0310N</p>  <p>○</p> <p>☒ L 120 x B 120 x H 60 ⑦ ☄ PET 📦 1</p>	<p>LID TO FIT ROUND SALAD TUB FACLW0231N</p>  <p>○</p> <p>☒ L 120 x B 120 x H 7 ⑧ ☄ PET 📦 1</p>	<p>HINGED LID FOLDOVER FACLP1029</p>  <p>○</p> <p>☒ L 355 x B 175 x H 40 ☄ PET 📦 1</p>	









○ NECK DIAMETER 📏 NECK TYPE 📐 SHAPE ☄ MATERIAL 📦 CLOSURE 📦 COMPONENTS ☒ DIMENSIONS (MM) / ○ STANDARD COLOUR OPTIONS AVAILABLE

<p>ROUND SALAD TUB - SMALL FACLO042N</p>  <p>○</p> <p>☒ L 88 x B 88 x H 40 ① ☄ PET 📦 1</p>	<p>LID TO FIT ROUND SALAD TUB FACLG0051</p>  <p>○</p> <p>☒ L 88 x B 88 x H 7 ② ☄ PET 📦 1</p>	<p>FOLDOVER TUB - 500G FACLP0971</p>  <p>○</p> <p>☒ L 260 x B 155 x H 55 ☄ PET 📦 1</p>	<p>GENERAL BOWL FACLP0733</p>  <p>○</p> <p>☒ L 267 x B 267 x H 66 ③ ☄ PET 📦 1</p>	<p>GENERAL BOWL FACLP0808</p>  <p>○</p> <p>☒ L 268 x B 268 x H 94 ③ ☄ PET 📦 1</p>	<p>RELATED PRODUCTS CUPS & TRAYS</p> <ul style="list-style-type: none"> ① LID TO FIT ROUND SALAD TUB FACLG0051 PG 62 ② ROUND SALAD TUB - SMALL FACLO042N PG 62 ③ LID FOR GENERAL BOWL FACLP0732 PG 62 ④ GENERAL BOWL FACLP0733 PG 62 ⑤ GENERAL BOWL FACLP0808 PG 62 ⑥ ROUND CATERING TRAY WITH DIVISIONS - LARGE FABLP452N PG 62 ⑦ ROUND CATERING TRAY FABLP451N PG 62 ⑧ CATERING DOME FACLP0744 PG 62
<p>LID FOR GENERAL BOWL FACLP0732</p>  <p>○</p> <p>☒ L 266 x B 266 x H 24 ④ ☄ PET ⑤ 📦 1</p>	<p>10 SIDED SALAD BOWL 2L (1.5KG) FACLP0417</p>  <p>○</p> <p>☒ L 217 x B 217 x H 100 ☄ PET 📦 1</p>	<p>CATERING DOME FACLP0744</p>  <p>○</p> <p>☒ L 450 x B 450 x H 70 ⑥ ☄ PET ⑦ 📦 1</p>	<p>ROUND CATERING TRAY WITH DIVISIONS - LARGE FABLP452N</p>  <p>○</p> <p>☒ L 435 x B 435 x H 20 ⑧ ☄ PET 📦 1</p>	<p>ROUND CATERING TRAY FABLP451N</p>  <p>○</p> <p>☒ L 435 x B 435 x H 20 ⑧ ☄ PET 📦 1</p>	

○ NECK DIAMETER 📏 NECK TYPE 📐 SHAPE ☄ MATERIAL 📦 CLOSURE 📦 COMPONENTS ☒ DIMENSIONS (MM) / ○ STANDARD COLOUR OPTIONS AVAILABLE

<p>BARRIER MEAT TRAY - NON-RECYCLABLE BLPETCLM1355L</p>  <p>○</p> <p>☒ L 240 x B 168 x H 55 ☸ PET (bPETLAM) 📦 1</p>	<p>BARRIER MEAT TRAY - NON-RECYCLABLE BLPETCLM1345L</p>  <p>○</p> <p>☒ L 240 x B 168 x H 45 ☸ PET (bPETLAM) 📦 1</p>	<p>BARRIER MEAT TRAY - NON-RECYCLABLE BLPETCLM1545L</p>  <p>○</p> <p>☒ L 260 x B 176 x H 45 ☸ PET (bPETLAM) 📦 1</p>	<p>BARRIER MEAT TRAY - NON-RECYCLABLE BLPETCLM1337L</p>  <p>○</p> <p>☒ L 240 x B 168 x H 37 ☸ PET (bPETLAM) 📦 1</p>	<p>LID 250G RECTANGULAR STRAWBERRY PUNNET FACLF0176</p>  <p>○</p> <p>☒ L 125 x B 165 x H 27 ☸ PET 📦 1</p>	<p>RELATED PRODUCTS CUPS & TRAYS</p> <ul style="list-style-type: none"> ① 250G RECTANGULAR STRAWBERRY PUNNET FACLF0175 PG 63 ② LID 250G RECTANGULAR STRAWBERRY PUNNET FACLF0176 PG 63 ③ 800G RECTANGULAR STRAWBERRY PUNNET FACLF0179 PG 63 ④ LID 800G RECTANGULAR STRAWBERRY PUNNET FACLF0180 PG 63
<p>250G RECTANGULAR STRAWBERRY PUNNET FACLF0175</p>  <p>○</p> <p>☒ L 155 x B 122 x H 40 ☸ PET 📦 1</p>	<p>LID 800G RECTANGULAR STRAWBERRY PUNNET FACLF0180</p>  <p>○</p> <p>☒ L 239 x B 163 x H 11 ☸ PET 📦 1</p>	<p>800G RECTANGULAR STRAWBERRY PUNNET FACLF0179</p>  <p>○</p> <p>☒ L 232 x B 156 x H 50 ☸ PET 📦 1</p>	<p>RECTANGULAR PUNNET MEDIUM FABLF0173</p>  <p>●</p> <p>☒ L 177 x B 127 x H 25 ☸ PET 📦 1</p>	<p>RECTANGULAR PUNNET SHALLOW FACLF0172</p>  <p>○</p> <p>☒ L 177 x B 127 x H 17 ☸ PET 📦 1</p>	









○ NECK DIAMETER 📏 NECK TYPE 📐 SHAPE ☸ MATERIAL 📦 CLOSURE 📦 COMPONENTS ☒ DIMENSIONS (MM) / ○ STANDARD COLOUR OPTIONS AVAILABLE

<p>SALAD TUB 1KG FACLP0985</p>  <p>☒ L 300 x B 159 x H 61 ① ☸ PET 📦 1</p>	<p>LID TO FIT SALAD TUB 1KG FACLP0986</p>  <p>☒ L 300 x B 159 x H 6 ② ☸ PET 📦 1</p>	<p>SALAD TUB 500G FACLP0955</p>  <p>☒ L 160 x B 160 x H 61 ③ ☸ PET 📦 1</p>	<p>LID TO FIT SALAD TUB 500G FACLP0921</p>  <p>☒ L 160 x B 160 x H 7 ④ ☸ PET 📦 1</p>	<p>DELI TRAY 250ML FACLP0394</p>  <p>☒ L 152 x B 132 x H 35 ⑤ ☸ PET 📦 1</p>	<p>RELATED PRODUCTS CUPS & TRAYS</p> <ul style="list-style-type: none"> ① LID TO FIT SALAD TUB 1KG FACLP0986 PG 64 ② SALAD TUB 1KG FACLP0985 PG 64 ③ LID TO FIT SALAD TUB 500G FACLP0921 PG 64 ④ SALAD TUB 500G FACLP0955 PG 64 ⑤ LID TO FIT DELI TRAY FACLP0396 PG 60 ⑥ SQUARE TUB LID FACLP0929 PG 64 ⑦ SQUARE TUB FACLP0928 PG 64 ⑧ TRIFLE LID FACLB0693 PG 64 ⑨ TRIFLE BOWL FACLB0692 PG 64 ⑩ LID TO FIT BON BON FACLS490 PG 65
<p>SQUARE TUB FACLP0928</p>  <p>☒ L 78 x B 78 x H 68 ⑥ ☸ PET 📦 1</p>	<p>SQUARE TUB LID FACLP0929</p>  <p>☒ L 84 x B 84 x H 42 ⑦ ☸ PET 📦 1</p>	<p>TRIFLE BOWL FACLB0692</p>  <p>☒ L 200 x B 200 x H 82 ⑧ ☸ PET 📦 1</p>	<p>TRIFLE LID FACLB0693</p>  <p>☒ L 203 x B 203 x H 15 ⑨ ☸ PET 📦 1</p>	<p>SHALLOW BON BON DESSERT BOWL FACLB0709</p>  <p>☒ L 170 x B 170 x H 67 ⑩ ☸ PET 📦 1</p>	









☉ NECK DIAMETER ☒ NECK TYPE ☐ SHAPE ☸ MATERIAL ☒ CLOSURE 📦 COMPONENTS ☒ DIMENSIONS (MM) / ○ STANDARD COLOUR OPTIONS AVAILABLE

<p>LID TO FIT BON BON FACLS490</p>  <p>○</p> <p>☒ L 170 x B 170 x H 10 ① ☄ PET 📦 1</p>	<p>ROUND SALAD TUB LARGE FACLP0604</p>  <p>○</p> <p>☒ L 182 x B 182 x H 80 ② ☄ PET 📦 1</p>	<p>LID TO FIT ROUND SALAD TUB LARGE FACLP0605</p>  <p>○</p> <p>☒ L 182 x B 182 x H 8 ③ ☄ PET 📦 1</p>	<p>LID TO FIT SQUARE TUB FACLF0225</p>  <p>○</p> <p>☒ L 126 x B 126 x H 10 ④ ☄ PET 📦 1</p>	<p>PET LID FACLP1023</p>  <p>○</p> <p>☒ L 189 x B 189 x H 18 ⑤ ☄ PET ⑥ 📦 1</p>	<p>RELATED PRODUCTS CUPS & TRAYS</p> <p>① SHALLOW BON BON BOWL FACLB0709 PG 64</p> <p>② LID TO FIT ROUND SALAD TUB LARGE FACLP0605 PG 65</p> <p>③ ROUND SALAD TUB LARGE FACLP0604 PG 65</p> <p>④ SQUARE TUB - SHALLOW FABLP0608 PG 60</p> <p>⑤ AUST PP TRAY TFT - 2 CAVITY LBLP1021 PG 67</p> <p>⑥ AUST PP TRAY TFT - 2 CAVITY LCLP1021 PG 67</p>
<p>RECTANGULAR BERRY PUNNET FACLF0200</p>  <p>○</p> <p>☒ L 270 x B 94 x H 30 ☄ PET 📦 1</p>	<p>FRUIT CLAMSHELL PACK 250G FACLF0230</p>  <p>○</p> <p>☒ L 190 x B 115 x H 29 ☄ PET 📦 1</p>	<p>SUSHI FOLD OVER TUB 38F FACLP1002</p>  <p>○</p> <p>☒ L 310 x B 203 x H 43.5 ☄ PET 📦 1</p>	<p>STRAWBERRY PUNNET 250G FACLF0257</p>  <p>○</p> <p>☒ L 233 x B 182 x H 32 ☄ PET 📦 1</p>	<p>FRUIT CLAMSHELL PACK 500G FACLF0231</p>  <p>○</p> <p>☒ L 190 x B 115 x H 50 ☄ PET 📦 1</p>	

○ NECK DIAMETER 📏 NECK TYPE 📐 SHAPE ☄ MATERIAL 📦 CLOSURE 📦 COMPONENTS ☒ DIMENSIONS (MM) / ○ STANDARD COLOUR OPTIONS AVAILABLE

<p>FRUIT CLAMSHELL PACK 750G FACLF0232</p>  <p>⊠ L 190 x B 115 x H 72 ♻️ PET 📦 1</p>	<p>FRUIT CLAMSHELL PACK 1KG FACLF0233</p>  <p>⊠ L 190 x B 115 x H 87 ♻️ PET 📦 1</p>	<p>BARRIER MEAT TRAY - RECYCLABLE BLPETCLM1837</p>  <p>⊠ L 275 x B 240 x H 37 ♻️ PET (bPET) 📦 1</p>	<p>BARRIER MEAT TRAY - NON-RECYCLABLE BLPETCLM1837L</p>  <p>⊠ L 275 x B 240 x H 37 ♻️ PET (bPETLAM) 📦 1</p>	<p>BARRIER MEAT TRAY - RECYCLABLE FABCLM1845</p>  <p>⊠ L 275 x B 240 x H 45 ♻️ PET (bPET) 📦 1</p>	<p>RELATED PRODUCTS CUPS & TRAYS</p>
<p>BARRIER MEAT TRAY - NON-RECYCLABLE BLPETCLM1845L</p>  <p>⊠ L 275 x B 240 x H 45 ♻️ PET(bPETLAM) 📦 1</p>	<p>BARRIER MEAT TRAY - RECYCLABLE FABCLM1648</p>  <p>⊠ L 205 x B 161 x H 48 ♻️ PET (bPET) 📦 1</p>	<p>BARRIER MEAT TRAY - RECYCLABLE FABCLM1640</p>  <p>⊠ L 205 x B 161 x H 40 ♻️ PET (bPET) 📦 1</p>	<p>RECIPE DISH - 1 CAVITY LCLP0533</p>  <p>⊠ L 204 x B 160 x H 32 ♻️ Polypropylene 📦 1</p>	<p>AUST PP TRAY TFT - 2 CAVITY LCLP1021</p>  <p>⊠ L 204 x B 160 x H 42 ♻️ Polypropylene 📦 1</p>	

⊙ NECK DIAMETER 📏 NECK TYPE 📐 SHAPE ♻️ MATERIAL 📦 CLOSURE 📦 COMPONENTS ⊠ DIMENSIONS (MM) / ○ STANDARD COLOUR OPTIONS AVAILABLE

<p>AUST PP TRAY TFT - 2 CAVITY LBLP1021</p>  <p>⑤</p> <p>☒ L 183 x B 133 x H 35 ☄ Polypropylene 📦 1</p>	<p>ROAST CHICKEN TRAY LBL0527</p>  <p>②</p> <p>☒ L 245 x B 175 x H 38 ☄ PET 📦 1</p>	<p>OVAL MEAL TRAY - 2 CAVITY LBLP0467</p>  <p>③ ④</p> <p>☒ L 230 x B 180 x H 33 ☄ PET 📦 1</p>	<p>PUNNET (BERRY / CHERRY TOMATO) FACLF0181</p>  <p>○</p> <p>☒ L 145 x B 95 x H 45 ☄ PET 📦 1</p>	<p>LONG BREAD ROLL DOME FACLB151N</p>  <p>○</p> <p>☒ L 225 x B 110 x H 44 ☄ PET 📦 1</p>	<p>RELATED PRODUCTS CUPS & TRAYS</p> <p>① ROAST CHICKEN TRAY LBL0527 PG 67</p> <p>② LID TO FIT ROAST CHICKEN TRAY LCL0528 PG 67</p> <p>③ FLAT LID TO FIT OVAL MEAT TRAY FACLP0477 PG 50</p> <p>④ HIGH LID TO FIT OVAL MEAT TRAY FACLP0821 PG 50</p> <p>⑤ PET LID FACLP1023 PG 65</p>
<p>LID TO FIT ROAST CHICKEN TRAY LCLP0528</p>  <p>○</p> <p>☒ L 245 x B 175 x H 70 ☄ PET 📦 1</p> <p>①</p>	<p>RECIPE DISH - 2 CAVITY LBLP0535</p>  <p>●</p> <p>☒ L 204 x B 160 x H 32 ☄ Polypropylene 📦 1</p>	<p>RECIPE DISH - 1 CAVITY LBLP0534</p>  <p>●</p> <p>☒ L 204 x B 160 x H 42 ☄ Polypropylene 📦 1</p>	<p>RECTANGULAR PUNNET - MEDIUM FABLF0171</p>  <p>●</p> <p>☒ L 159 x B 121 x H 35 ☄ PET 📦 1</p>		

SECTION 8 //

MISCELLANEOUS



ENVIROHANGER
A000.0000.SAM.HANG.0



100% PIR Recycled Plastic
Glossy
1

5ML MEDICINE SPOON
RPC_GN0030

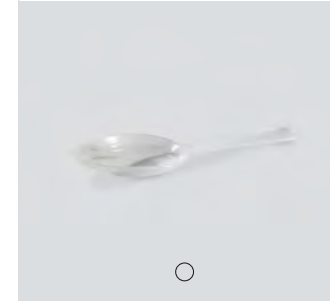

PP
Glossy
1

RELATED PRODUCTS
NA

PET FOOD HANDLE
IKH001 / IKH002 / IKH003 /
IKH004 / IKH005

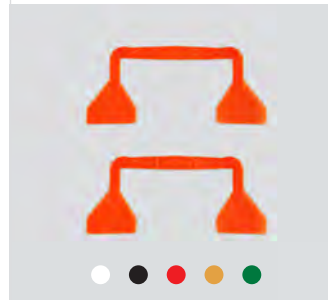

HDPE
Smooth, Glossy
2



BERRY ASTRAPAK // +27 10 015 5200 // ASTRAPAKSALES@BERRYGLOBAL.COM

WWW.ASTRAPAK.COM